

porcelain

Arkitekt
Pool

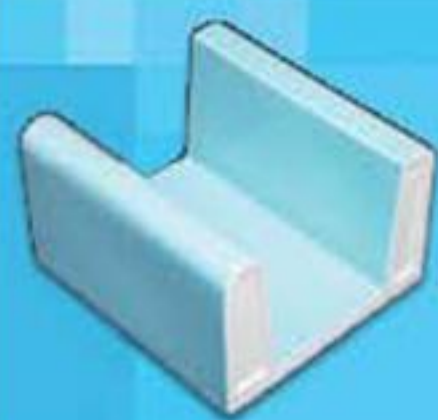

Wiesbaden Sistemi
System Wiesbaden
System Wiesbaden
Système Wiesbaden

İçten Taşmalı - Izgarasız Geniş Kanal
Low Water Level Overflow - Wide Channel Without Grate
Tiefliegend - Große Rinne Ohne Abdeckrost
Avec Niveau D'eau Bas - Goulotte Large Sans Grille



Arkitekt Pool

Arkitekt Pool Havuz Parçaları. Moulded Trims. Formstücke. Pièces moulées

Wiesbaden Sistemi içten taşmalı - izgarasız geniş kanal
 System Wiesbaden low water level overflow - wide channel without grate
 System Wiesbaden tiefliedend - große Rinne ohne Abdeckrost
 Système Wiesbaden avec niveau d'eau bas - goulotte large sans grille

Wiesbaden Sistemi
 içten taşmalı -
 izgarasız geniş kanal

Olympic Pool



RAL
5002



RAL
9016



RAL
2307015

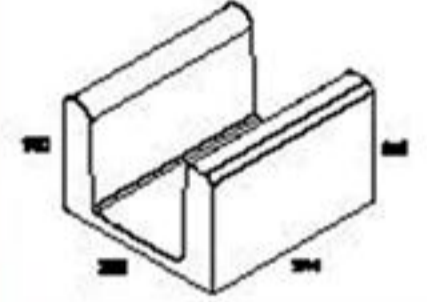
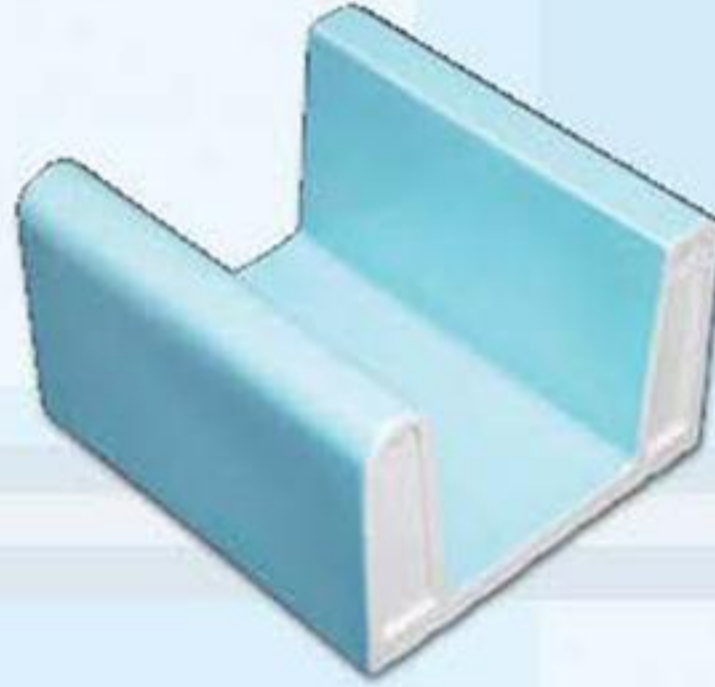

RAL 5002
 RAL 9016
 RAL 2307015

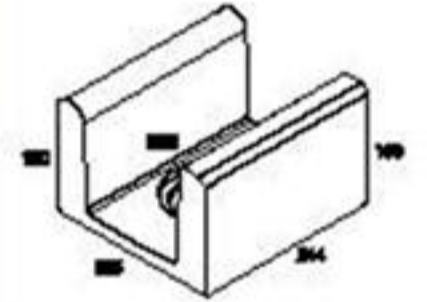
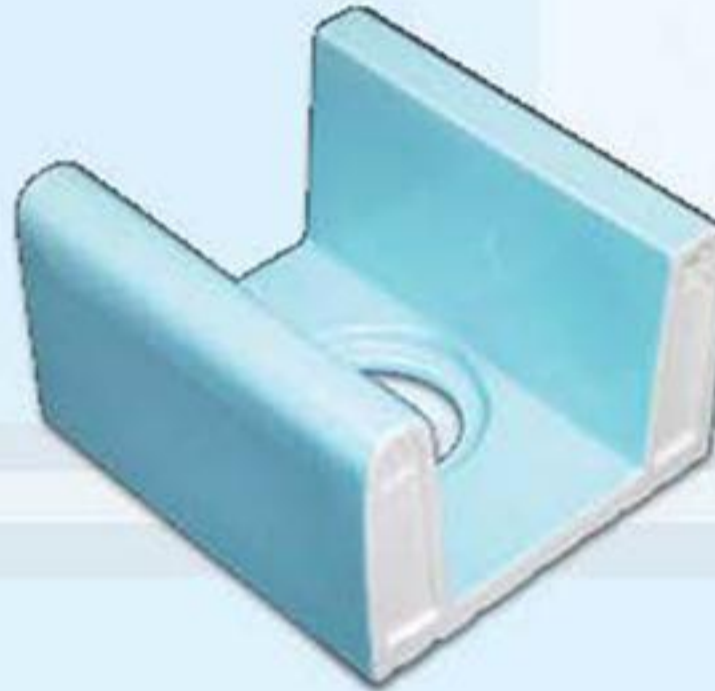

RAL 5002
 RAL 9016
 RAL 2307015

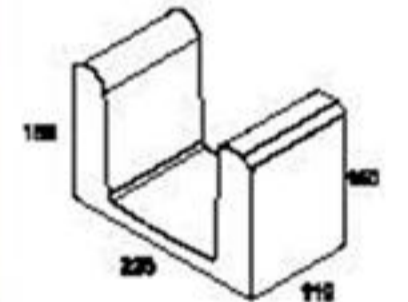
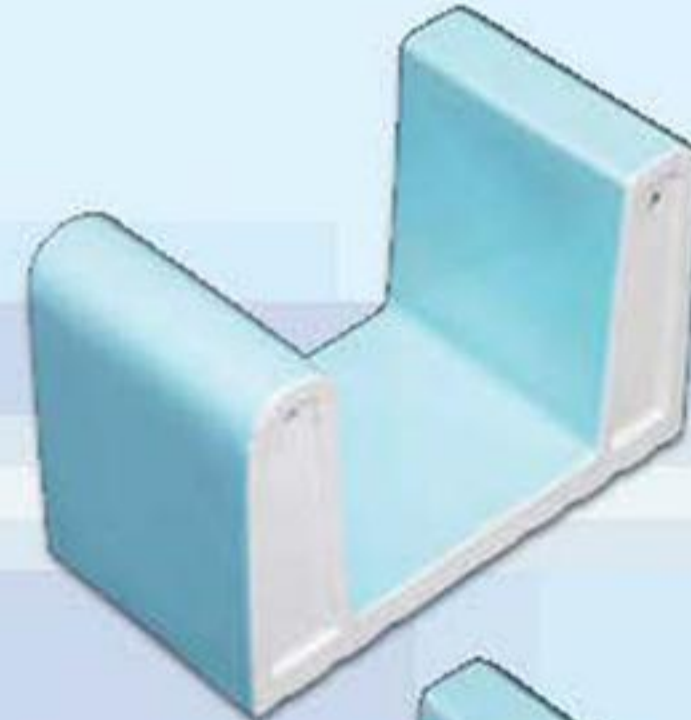

RAL 5002
 RAL 9016
 RAL 2307015

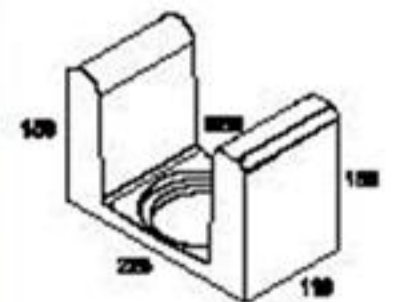

RAL 5002
 RAL 9016
 RAL 2307015



Parlak Glossy Glänzend Brillant	Mat Matt	Fiyat grubu Price group Preisgruppe Groupe de prix		Ölçü Dimension Maße Dimensions	Adet/m Pièces/m Stüçk/m Pièces/m	Adet/ kutu Pièces/Box Stüçk/Palet Pièces/boîte	m ² / kutu m ² /Box m ² /Palet m ² /boîte	kg/ kutu kg/Box kg/Palet kg/boîte
Geniş kanal Wide channel Große Überlaufrinne Goulotte large								
		EI-728		22 5x244x150 / 150 mm	4	1		5,20
		EI-728			4	1		5,20
		EI-728			4	1		5,20
Delikli geniş kanal Wide channel with outlet Große Überlaufrinne mit Ablauf Goulotte large avec écoulement								
		EI-728		22 5x244x150 / 150 mm Ø 86	4	1		5,00
		EI-728			4	1		5,00
		EI-728			4	1		5,00
Yarım geniş kanal Halfwide channel Große halbe Überlaufrinne Goulotte large demi longue								
		EI-650		22 5x19x150 / 150 mm	8	2		6,20
		EI-650			8	2		6,20
		EI-650			8	2		6,20
Delikli yarım geniş kanal Halfwide channel with outlet Große halbe Überlaufrinne mit Ablauf Goulotte large demi longue avec écoulement								
		EI-650		22 5x19x150 / 150 mm Ø 86	8	2		5,80
		EI-650			8	2		5,80
		EI-650			8	2		5,80

Arkitekt Pool

Arkitekt Pool Havuz Parçaları. Moulded Trims. Formstücke. Pièces moulées

Wiesbaden Sistemi içten taşmalı - izgarasız geniş kanal
 System Wiesbaden low water level overflow - wide channel without grate
 System Wiesbaden tiefliedend - große Rinne ohne Abdeckrost
 Système Wiesbaden avec niveau d'eau bas - goulotte large sans grille

Wiesbaden Sistemi
 içten taşmalı -
 izgarasız geniş kanal

Olympic Pool



RAL
5002



RAL
9016



RAL
2307015

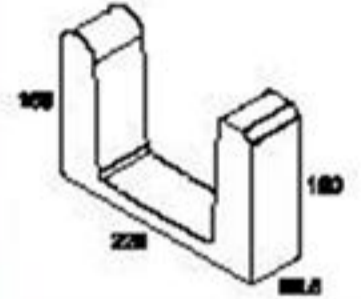
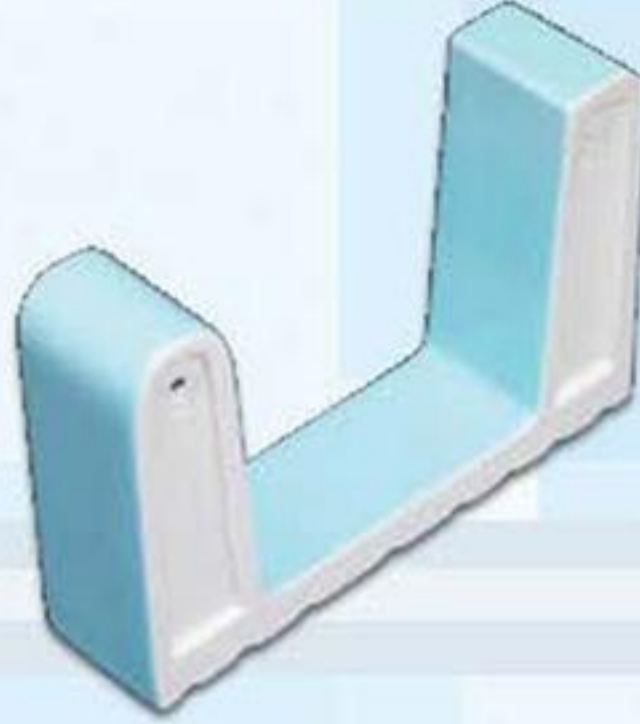

RAL 5002
 RAL 9016
 RAL 2307015

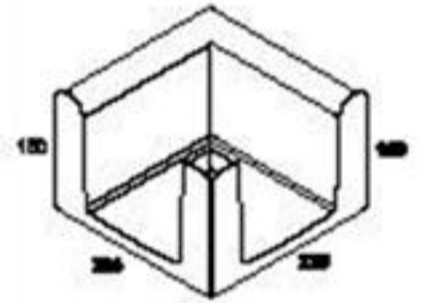
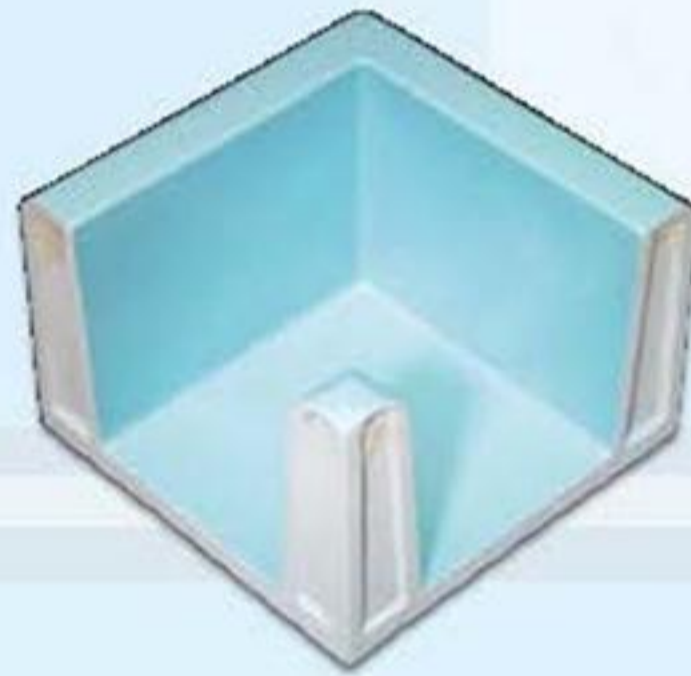

RAL 5002
 RAL 9016
 RAL 2307015

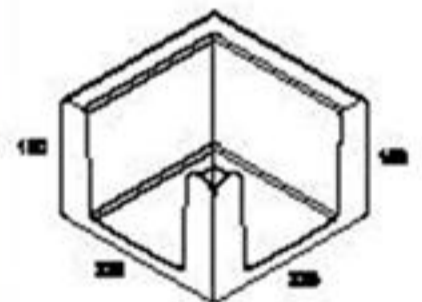

RAL 5002
 RAL 9016
 RAL 2307015

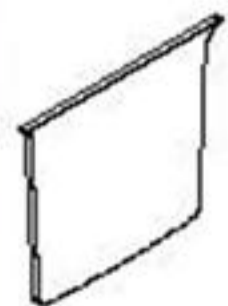

RAL 5002
 RAL 9016
 RAL 2307015

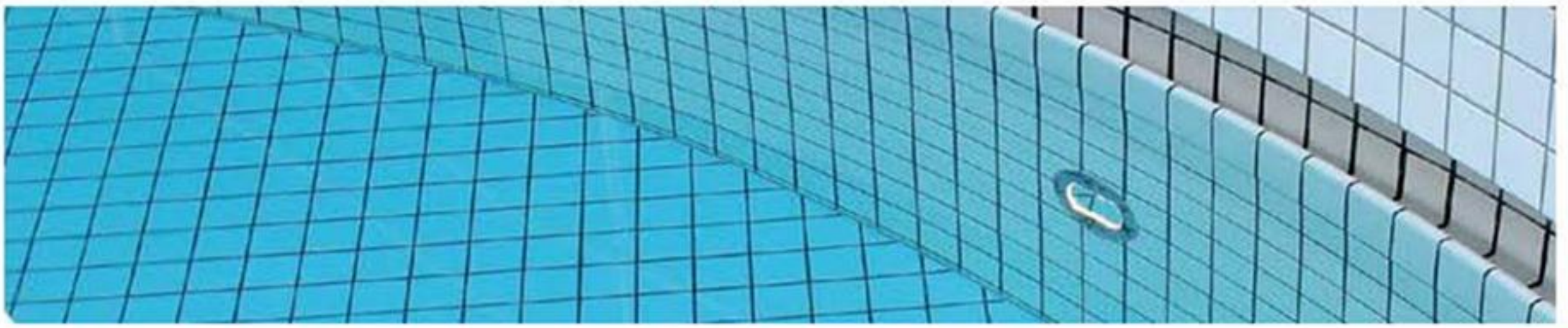

Parlak Glossy Glänzend Brillant	Mat Matt	Fiyat grubu Price group Preisgruppe Groupe de prix		Ölçü Dimension Maße Dimensions	Adet/m Pièces/m Stüçk/m Pièces/m	Adet/ kutu Pièces/Box Stüçk/Palet Pièces/boîte	m ² / kutu m ² /Box m ² /Palet m ² /boîte	kg/ kutu kg/Box kg/Palet kg/boîte
Çeyrek geniş kanal Quarter wide channel Große viertel Überlaufrinne Goulotte large d'un quart de longueur				22.5x56.5x150 / 150 mm				
		EI-620			16	4		5.00
		EI-620			16	4		5.00
		EI-620			16	4		5.00
Geniş kanal iç kögesi Wide channel internal corner Große Überlaufrinne Innenecke Goulotte large angle intérieur				22.5x22.5x150 / 150 mm				
		EI-710				1		5.00
		EI-710				1		5.00
		EI-710				1		5.00
Geniş kanal dış kögesi Wide channel external corner Große Überlaufrinne Außenecke Goulotte large angle extérieur				22.5x22.5x150 / 150 mm				
		EI-710				1		5.00
		EI-710				1		5.00
		EI-710				1		5.00
Geniş tahta (sağ/sol) Wide end piece (right/left) End platte (Rechte/linke) About large (droit-gauche)				Geniş kanala uyumludur Compatible with wide channel Passend zur großen Rinne Conforme avec goulotte large				
		EI-605				1		0.40
		EI-605				1		0.40
		EI-605				1		0.40



Schloßbad, Wickrath, GERMANY



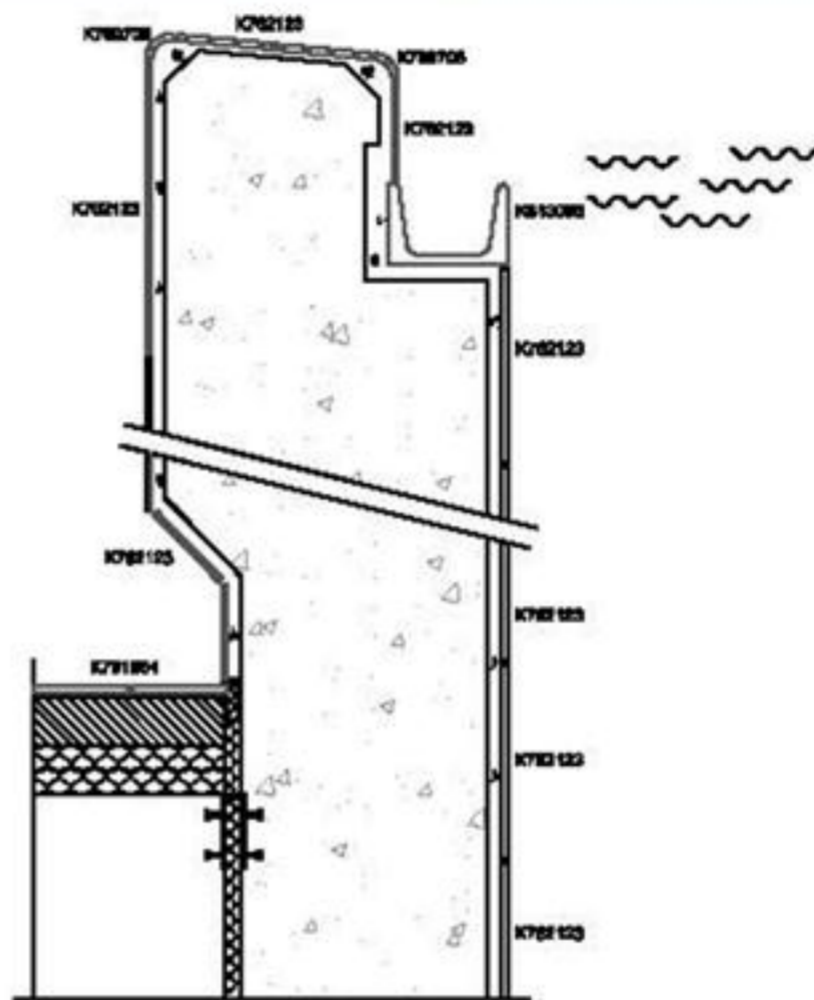

Arkitekt
Pool



Wiesbaden Sistemi
System Wiesbaden
System Wiesbaden
Système Wiesbaden

İçten Taşmalı - Izgarasız Dar Kanal
Low Water Level Overflow - Narrow Channel Without Grate
Tiefliegend - Kleine Rinne Ohne Abdeckrost
Avec Niveau D'eau Bas - Goulotte Étroite Sans Grille



Arkitekt Pool

Arkitekt Pool Havuz Parçaları. Moulded Trims. Formstücke. Pièces moulées

Wiesbaden Sistemi içten taşmalı - izgarasız dar kanal
 System Wiesbaden low water level overflow - narrow channel without grate
 System Wiesbaden tieflegend - kleine Rinne ohne Abdeckrost
 Système Wiesbaden avec niveau d'eau bas - goulotte étroite sans grille

Wiesbaden Sistemi
 içten taşmalı -
 izgarasız dar kanal

Olympic Pool



RAL
5002



RAL
9016



RAL
2307015

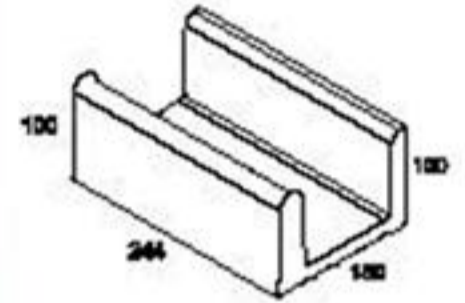
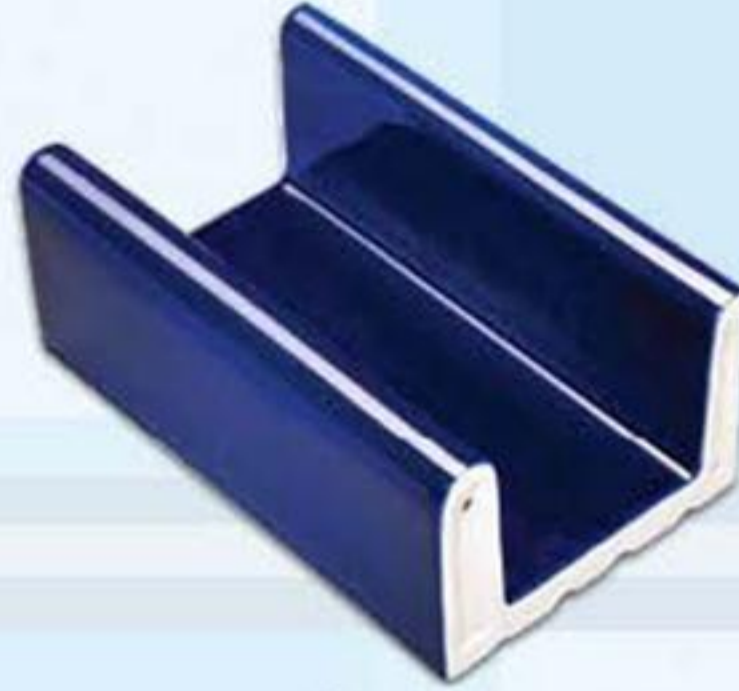

RAL 5002
 RAL 9016
 RAL 2307015

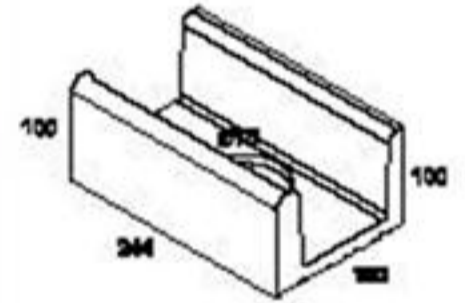

RAL 5002
 RAL 9016
 RAL 2307015

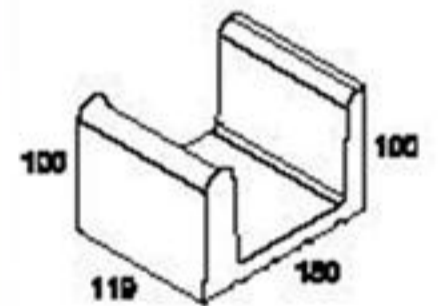

RAL 5002
 RAL 9016
 RAL 2307015

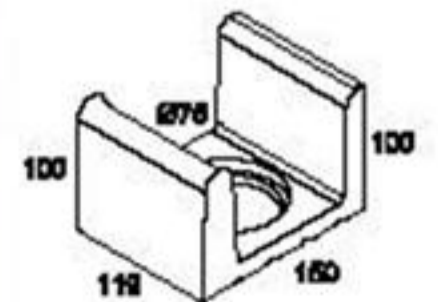

RAL 5002
 RAL 9016
 RAL 2307015



Parlak Glossy Glänzend Brillant	Mat Matt	Fiyat grubu Price group Preisgruppe Groupe de prix		Ölçü Dimension Maße Dimensions	Adet/m Pieces/m Stück/m Pièces/m	Adet/Kutu Pieces/Box Stück/Paket Pièces/Boite	m ² /Kutu m ² /Box m ² /Paket m ² /Boite	kg/Kutu kg/Box kg/Paket kg/Boite
Dar kanal Narrow channel Kleine Überlaufrinne Goulotte étroite								
				150x244x100 / 100 mm				
K813075		E1-710			4	2		6.40
K813090		E1-710			4	2		6.40
K813086		E1-710			4	2		6.40
Delikli dar kanal Narrow channel with outlet Kleine Überlaufrinne mit Ablauf Goulotte étroite avec écoulement								
				150x244x100 / 100 mm Ø75				
K813134		E1-710			4	2		6.20
K813156		E1-710			4	2		6.20
K813145		E1-710			4	2		6.20
Yarım dar kanal Half narrow channel Kleine halbe Überlaufrinne Goulotte étroite demi longue								
				150x119x100 / 100 mm				
K829153		E1-638			8	2		3.20
K829142		E1-638			8	2		3.20
K829164		E1-638			8	2		3.20
Delikli yarım dar kanal Half narrow channel with outlet Kleine halbe Überlaufrinne mit Ablauf Goulotte étroite demi longue avec écoulement								
				150x119x100 / 100 mm Ø75				
K829212		E1-638			8	2		3.10
K829201		E1-638			8	2		3.10
K829223		E1-638			8	2		3.10

Arkitekt Pool

Arkitekt Pool Havuz Parçaları. Moulded Trims. Formstücke. Pièces moulées

Wiesbaden Sistemi içten taşmalı - izgarasız dar kanal
 System Wiesbaden low water level overflow - narrow channel without grate
 System Wiesbaden tiefliedend - kleine Rinne ohne Abdeckrost
 Système Wiesbaden avec niveau d'eau bas - goulotte étroite sans grille

Wiesbaden Sistemi
 içten taşmalı -
 izgarasız dar kanal

Olympic Pool



RAL
5002



RAL
9016



RAL
2307015

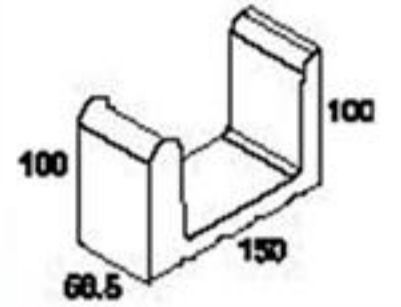

RAL 5002
 RAL 9016
 RAL 2307015

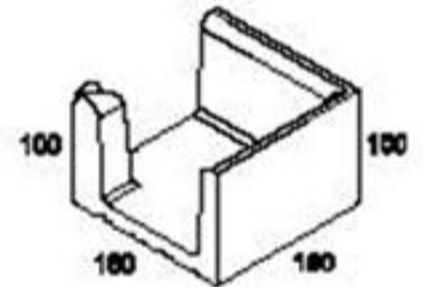
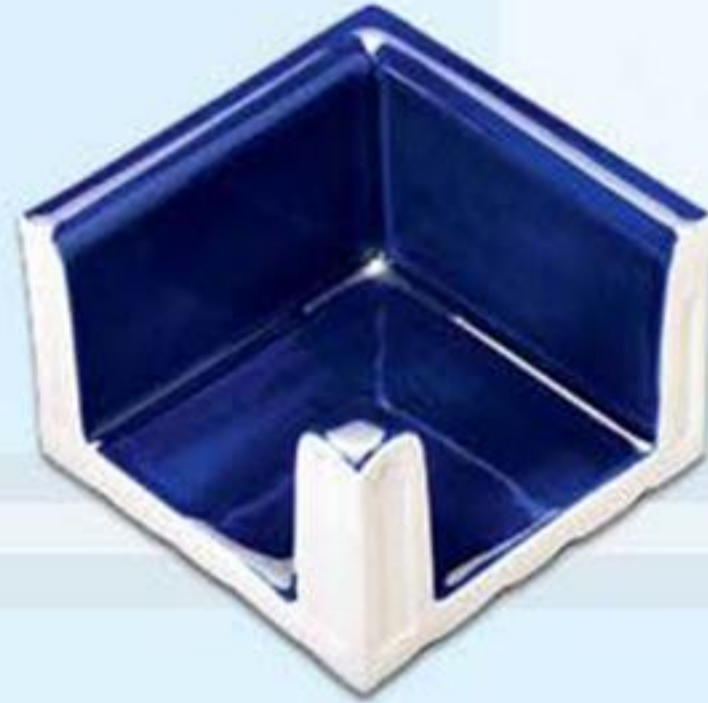

RAL 5002
 RAL 9016
 RAL 2307015

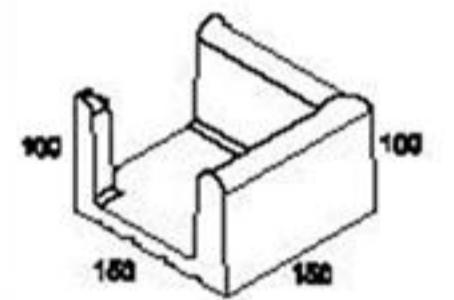

RAL 5002
 RAL 9016
 RAL 2307015

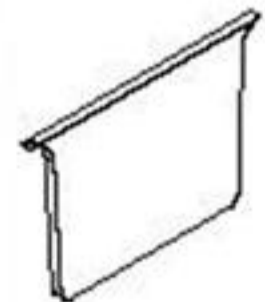

RAL 5002
 RAL 9016
 RAL 2307015



Parlak Glossy Glänzend Brillant	Mat Matt	Fiyat grubu Price group Preisgruppe Groupe de prix		Ölçü Dimension Maße Dimensions	Adet/m Pieces/m Stück/m Pièces/m	Adet/Kutu Pieces/Box Stück/Paket Pièces/Boite	m ² /Kutu m ² /Box m ² /Paket m ² /Boite	kg/Kutu kg/Box kg/Paket kg/Boite
Çeyrek dar kanal Quarter narrow channel Kleine viertel Überlaufrinne Goulotte étroite d'un quart de longue				150x56,5x100 / 100 mm				
K829186		E1-591			16	4		3.10
K829175		E1-591			16	4		3.10
K829190		E1-591			16	4		3.10
Dar kanal iç köşesi Narrow channel internal corner Kleine Überlaufrinne Innenecke Goulotte étroite angle intérieur				150x150x100 / 100 mm				
K813226		E1-702				1		170
K813241		E1-702				1		170
K813230		E1-702				1		170
Dar kanal dış köşesi Narrow channel external corner Kleine Überlaufrinne Außenecke Goulotte étroite angle extérieur				150x150x100 / 100 mm				
K813285		E1-702				1		090
K813300		E1-702				1		090
K813296		E1-702				1		090
Dar kapak (sağ/sol) Narrow end piece (right/left) Endplatte (Rechte/Linke) About étroit (droit-gauche)				Dar kanala uyumludur Compatible with narrow channel Passend zur kleinen Rinne Conforme avec goulotte étroite				
K831220		E1-576				1		0.25
K831231		E1-576				1		0.25
K831242		E1-576				1		0.25





0.8m

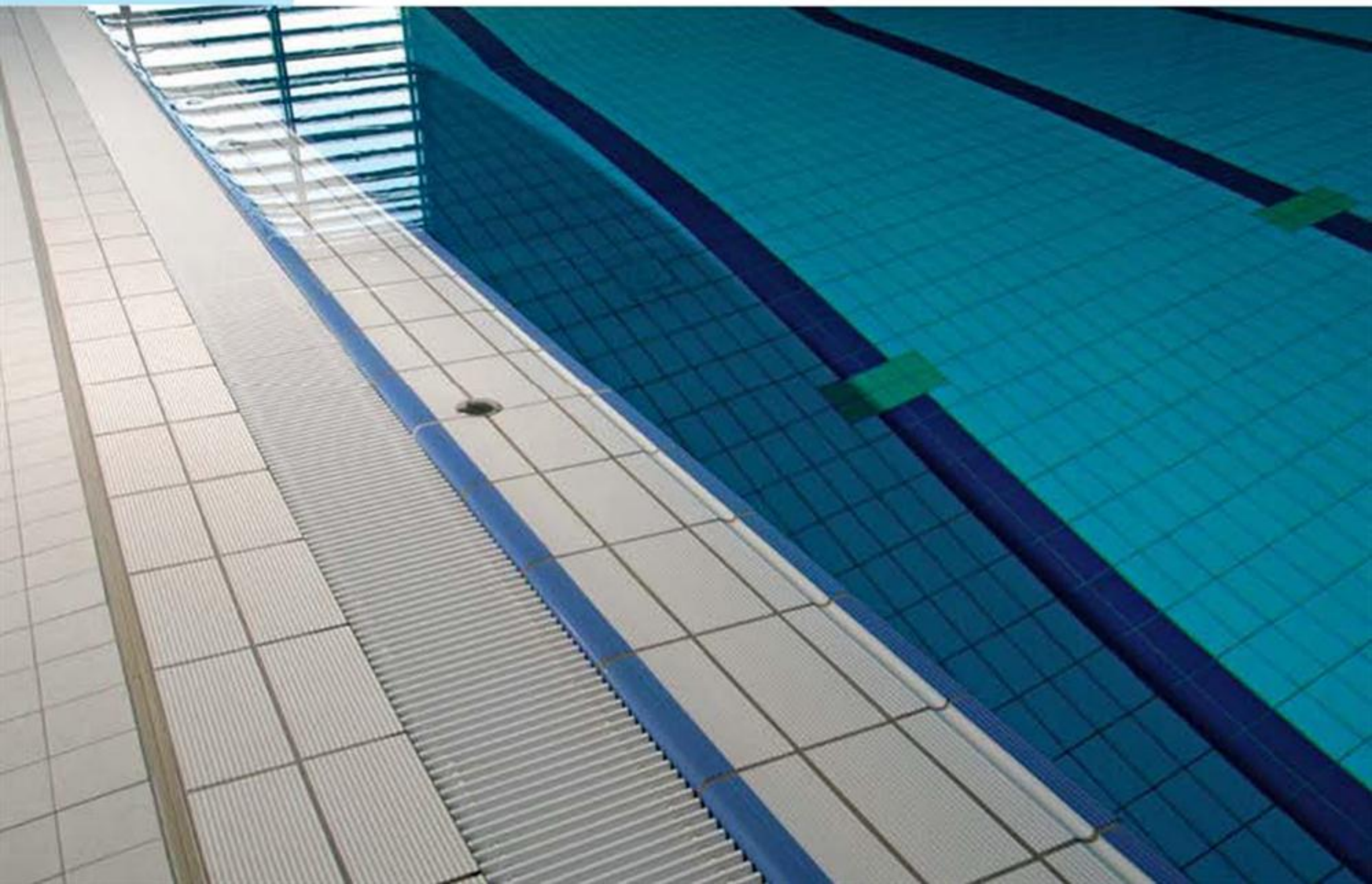
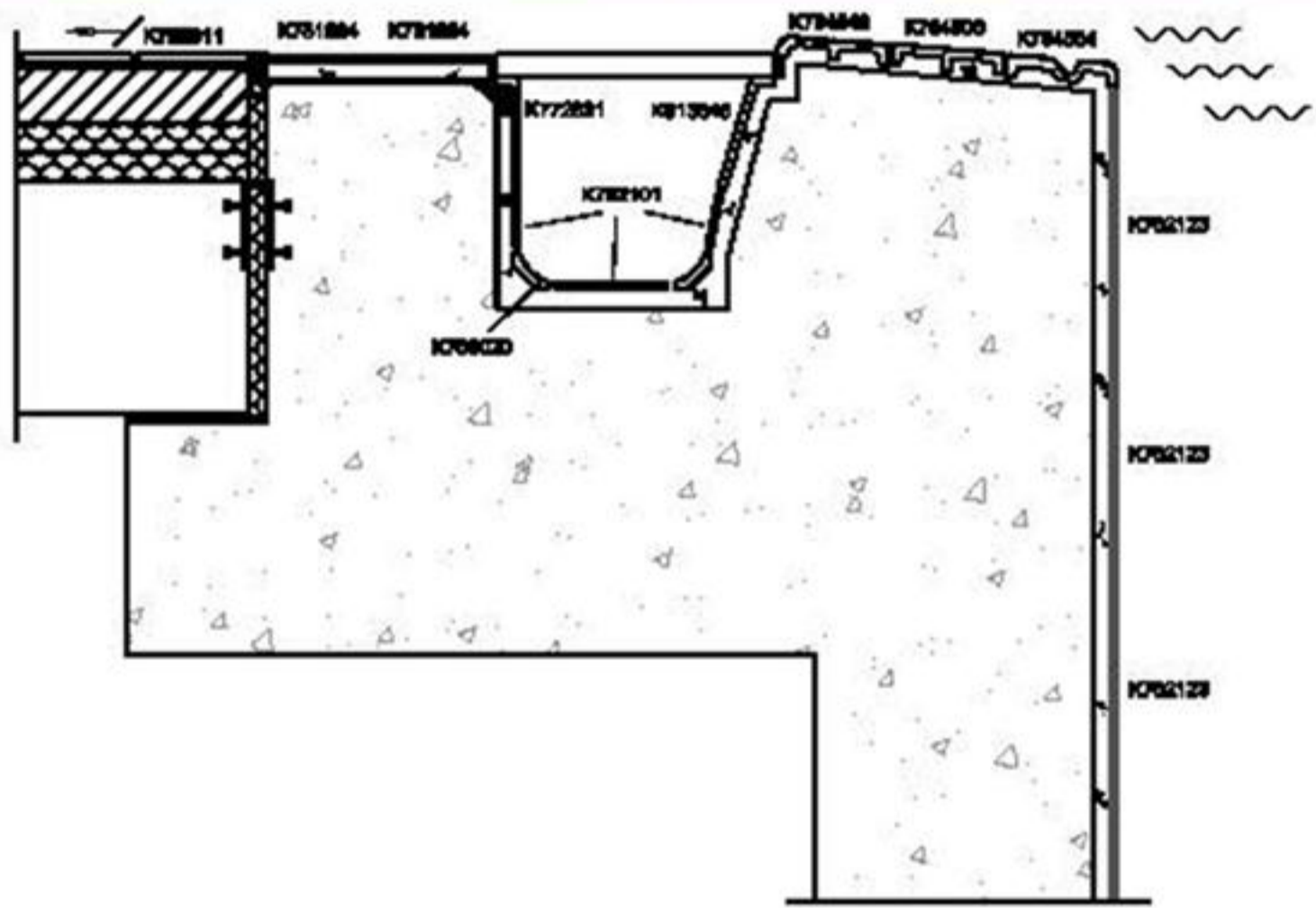

porcelain

Arkitekt
Pool

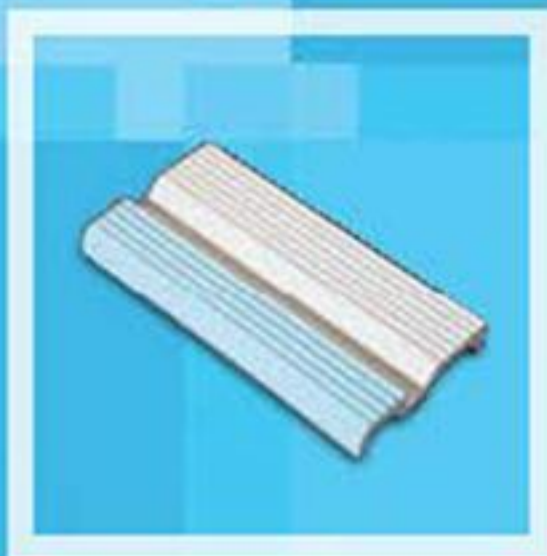

Fin Sistemi
Finnish Overflow System
System Finland
Système Finlandais

Üstten Taşmalı
High Water Level Overflow
Hochliegend
Avec Niveau D'eau Élevé



Arkitekt Pool

Arkitekt Pool Havuz Parçaları. Moulded Trims. Formstücke. Pièces moulées

Fin Sistemi üstten taşmalı
Finnish Overflow System high water level overflow
System Finland hochliegend
Système Finlandais avec niveau d'eau élevé

Fin Sistemi üstten taşmalı

Olympic Pool



RAL 5002



RAL 2907015

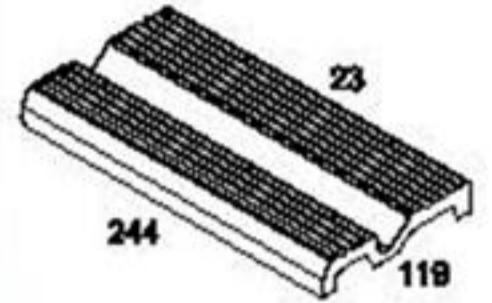
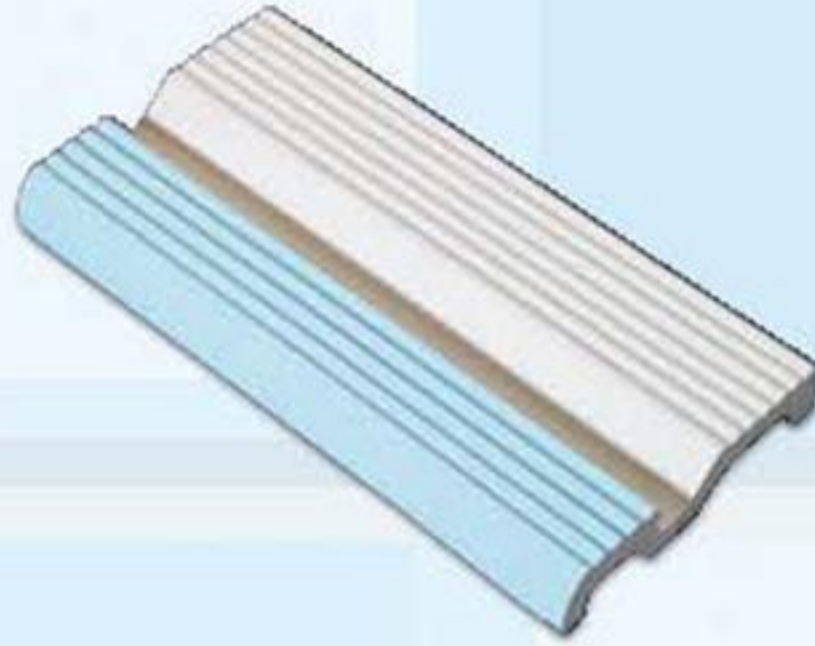

RAL 5002
RAL 2907015

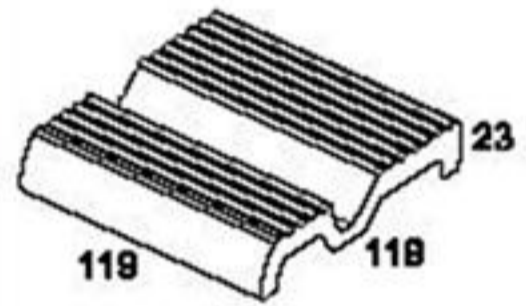
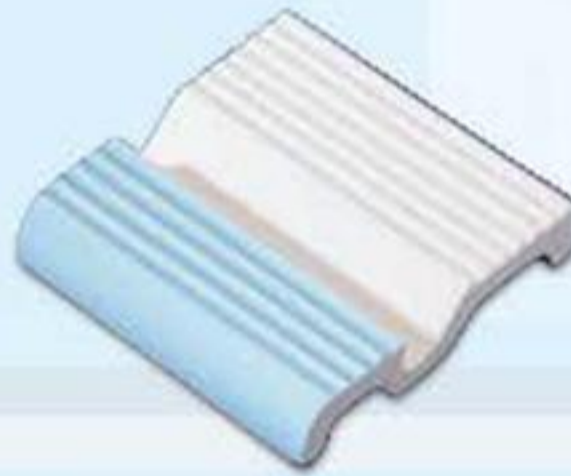

RAL 5002
RAL 2907015

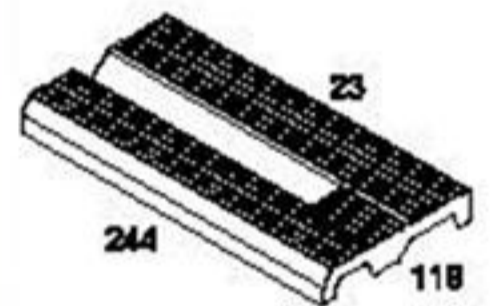
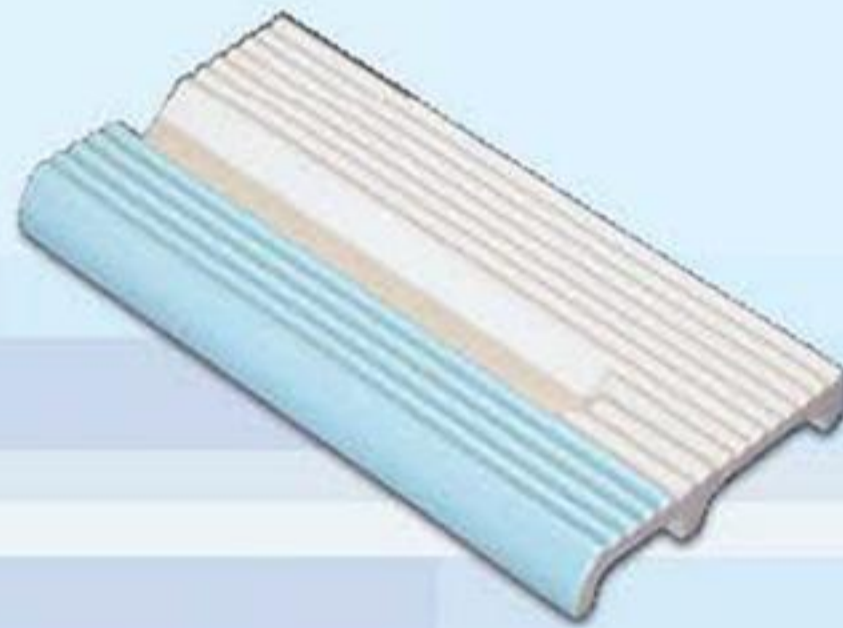



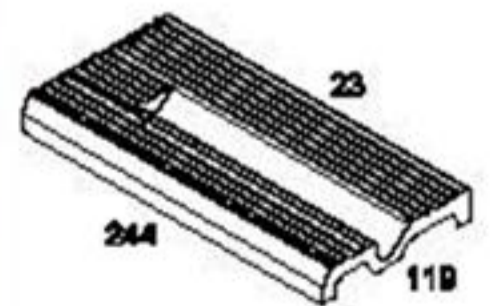
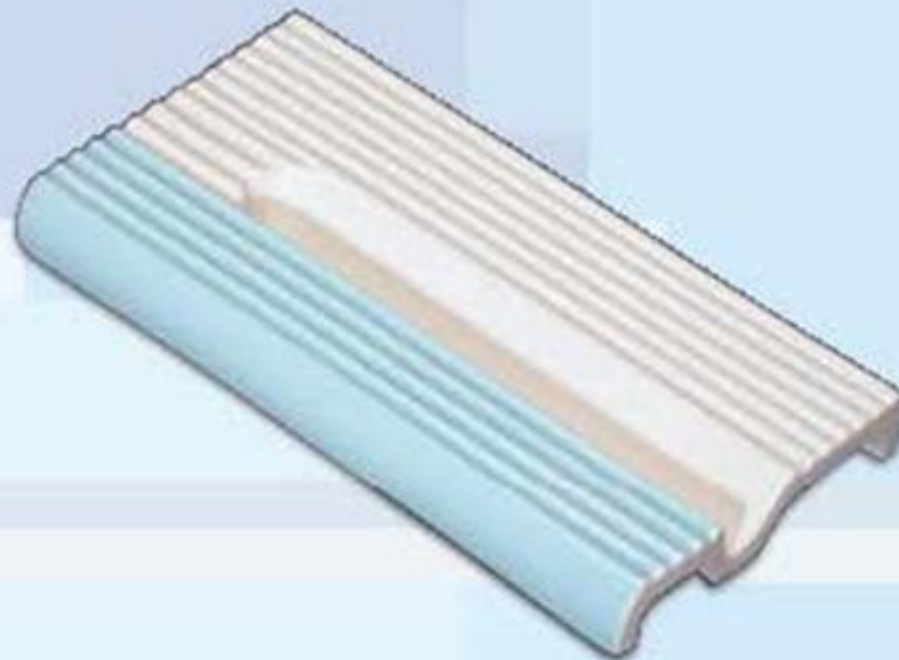





RAL 5002
RAL 2907015



RAL 5002
RAL 2907015



Parlak Glossy Glänzend Brillant	Mat Matt	Fiyat grubu Price group Preisgruppe Groupe de prix		Ölçü Dimension Maße Dimensions	Adet/m Pieces/m Stüct/m Pièces/m	Adet/ kutu Pieces/Box Stüct/Palet Pièces/Boite	m ² / kutu m ² /Box m ² /Palet m ² /Boite	kg/ kutu kg/Box kg/Palet kg/Boite
Havuz tutamağı Pool edge with finger grip Handfassenstein Rebord avec main courante								
1076435	1076434	E1-59	C 	M 12,5x2,5 cm 119x244x23 mm	4	8		6,90
1076453	1076452	E1-59	C 		4	8		6,90
Yarım havuz tutamağı Half pool edge with finger grip Halber Handfassenstein Demi-rebord avec main courante								
10880274	10880263	E1-54	C 	M 12,5x12,5 cm 119x119x23 mm	8	16		8,00
10880296	10880285	E1-54	C 		8	16		8,00
Havuz sağ bitiş tutamağı Pool edge right end with finger grip Handfassenstein, rechte Seite About droit de rebord avec main courante								
1078444	1078433	E1-50	C 	M 12,5x2,5 cm 119x244x23 mm	4	8		7,20
1078466	1078455	E1-50	C 		4	8		7,20
Havuz sol bitiş tutamağı Pool edge left end with finger grip Handfassenstein, linke Seite About gauche de rebord avec main courante								
1078481	1078470	E1-50	C 	M 12,5x2,5 cm 119x244x23 mm	4	8		7,20
1078503	1078492	E1-50	C 		4	8		7,20

Arkitekt Pool

Arkitekt Pool Havuz Parçaları. Moulded Trims. Formstücke. Pièces moulées

Fin Sistemi üstten taşmalı
Finnish Overflow System high water level overflow
System Finland hochliegend
Système Finlandais avec niveau d'eau élevé

Fin Sistemi üstten taşmalı

Olympic Pool



RAL 5002



RAL 2307015

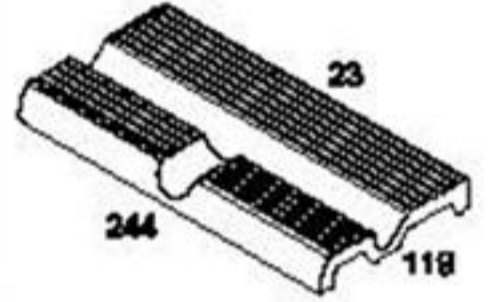
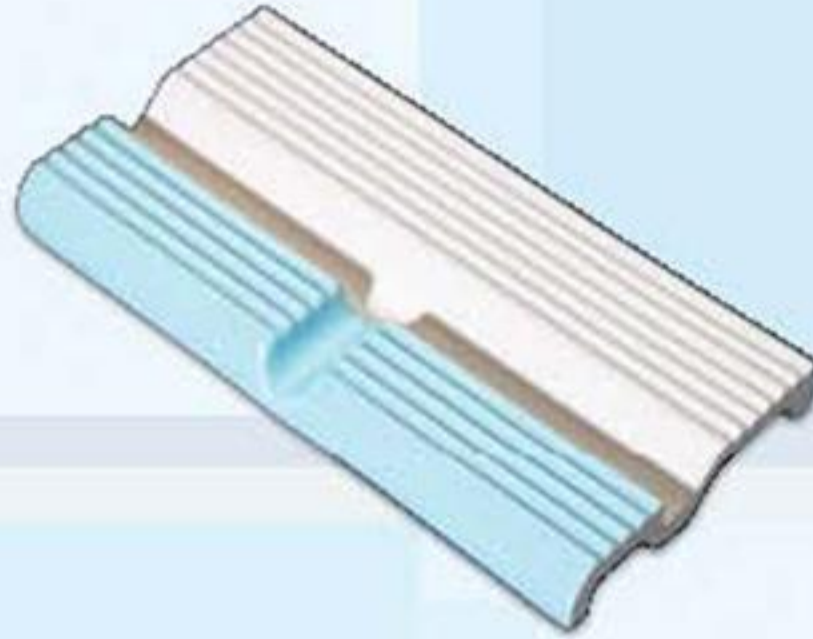

RAL 5002
RAL 2307015

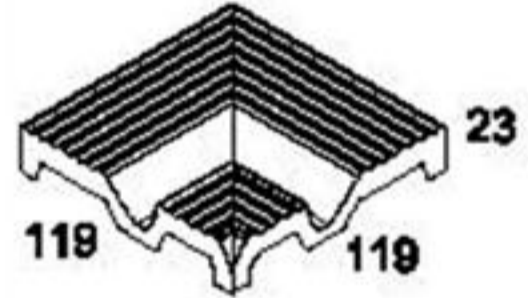

RAL 5002
RAL 2307015

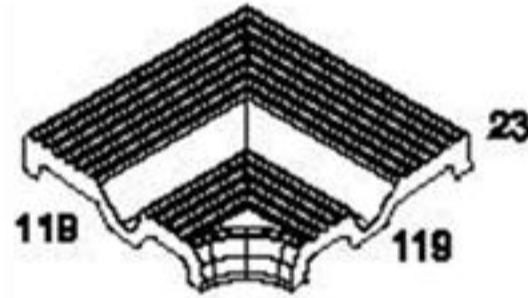
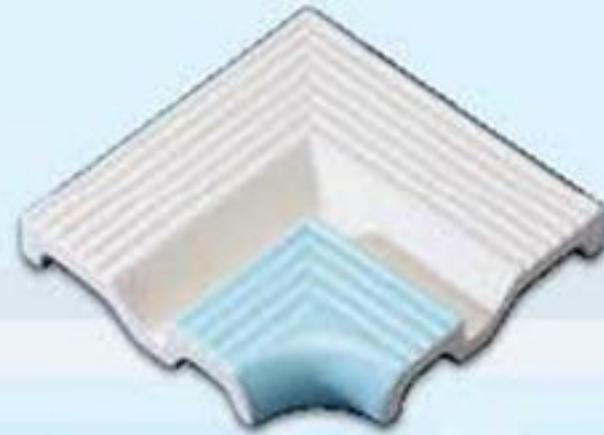

RAL 5002
RAL 2307015

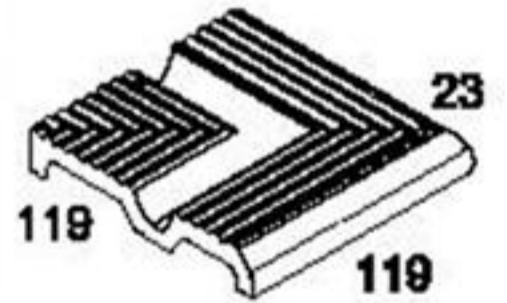



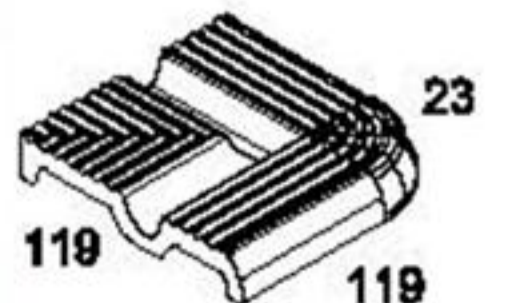







RAL 5002
RAL 2307015



RAL 5002
RAL 2307015



Parlak Glossy Glänzend Brillant	Mat Matt	Fiyat grubu Price group Preisgruppe Groupe de prix		Ölçü Dimension Maße Dimensions	Adet/m Pieces/m Stüct/m Pièces/m	Adet/ kutu Pieces/Box Stüct/Palet Pièces/Boite	m ² / kutu m ² /Box m ² /Palet m ² /Boite	kg/ kutu kg/Box kg/Palet kg/Boite
Oluklu havuz tutamağı Pool edge with finger grip and outlet Handfassenstein mit Ablauf Rebord avec main courante								
1076926	1076990	E1-59	C 	M 12,5x2,5 cm 119x244x23 mm	4	8		6,90
1076904	10769915	E1-59	C 		4	8		6,90
Havuz tutamağı iç köşesi Pool edge with finger grip internal corner Handfassenstein Innenecke Angle intérieur de rebord avec main courante								
10764735	10764724	E1-34	C 	M 12,5x12,5 cm 119x119x23 mm		4		2,00
10764713	10764702	E1-34	C 			4		2,00
Profilli havuz tutamağı iç köşesi Profiled pool edge with finger grip internal corner Handfassenstein Innenecke mit Profil Angle intérieur de rebord avec main courante avec profil								
10772466	10772435	E1-346	C 	M 12,5x12,5 cm 119x150x23 mm		4		2,75
10772481	10772470	E1-346	C 			4		2,75
Havuz tutamağı dış köşesi Pool edge with finger grip external corner Handfassenstein Außenecke Angle extérieur de rebord avec main courante								
10764691	10764680	E1-34	C 	M 12,5x12,5 cm 119x119x23 mm		4		2,00
10764676	10764665	E1-34	C 			4		2,00
Profilli havuz tutamağı dış köşesi Profiled pool edge with finger grip external corner Handfassenstein Außenecke mit Profil Angle extérieur de rebord avec main courante avec profil								
10772503	10772492	E1-346	C 	M 12,5x12,5 cm 119x119x23 mm		4		2,00
10772525	10772514	E1-346	C 			4		2,00



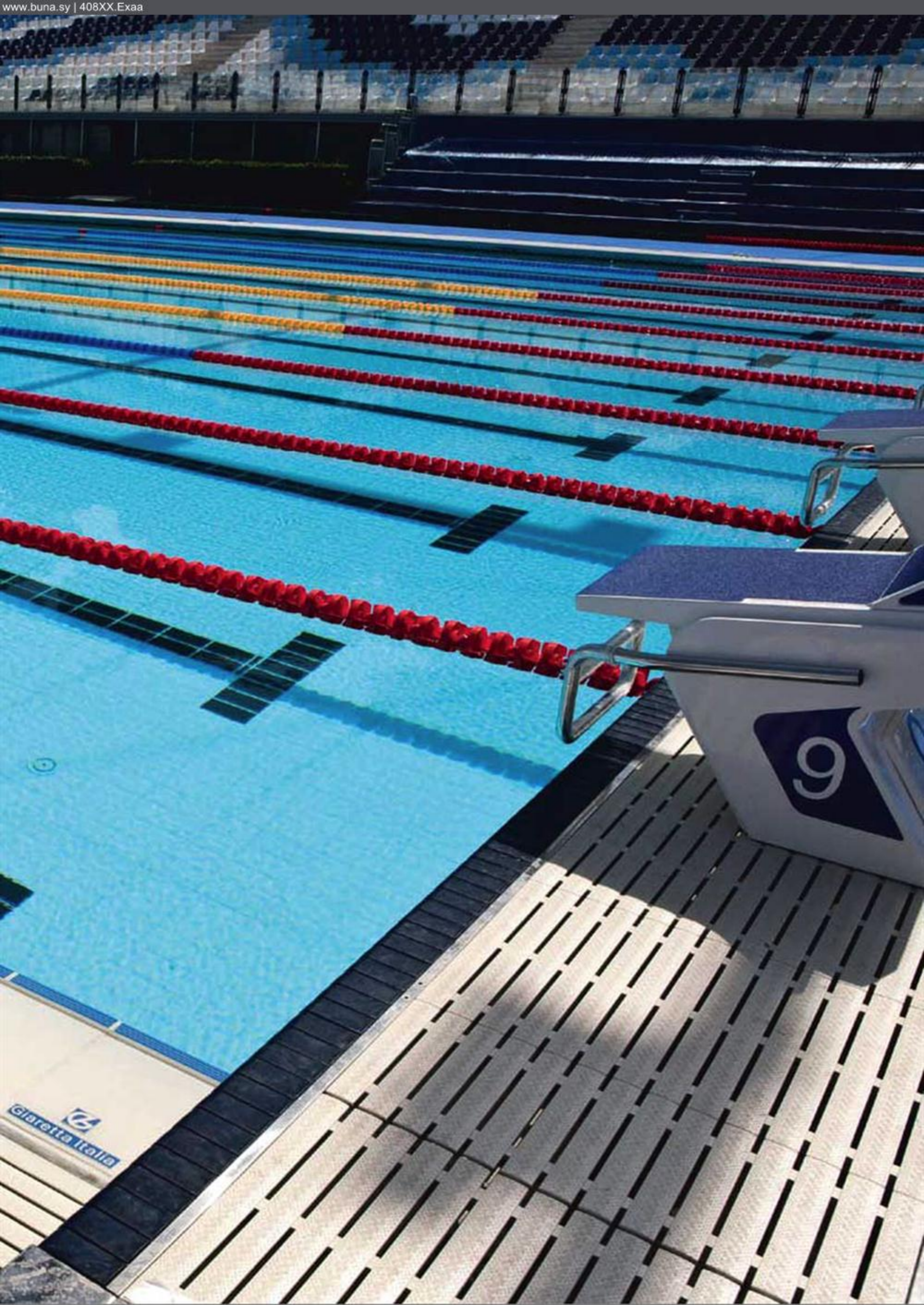

Giaretta Italia

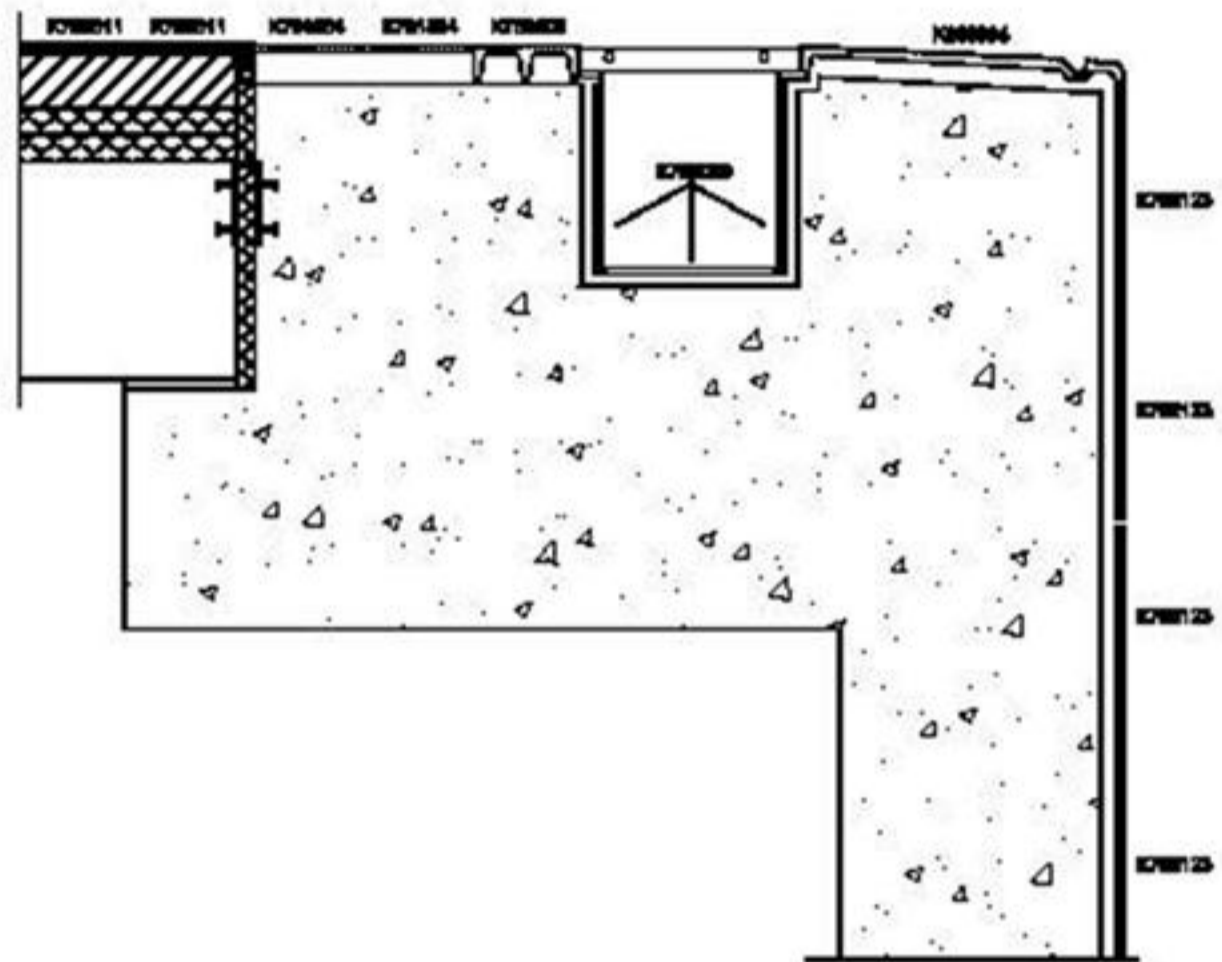

Arkitekt
Pool



Fin Sistemi
Finnish Overflow System
System Finnland
Système Finlandais

Izgara Ayaklı
High Water Level - With Channel Edge
Hochliegend - Mit Integriertem Rostaufleger
Avec Niveau D'eau Élevé - Avec Goulotte



Arkitekt Pool

Arkitekt Pool Havuz Parçaları. Moulded Trims. Formstücke. Pièces moulées

Fin Sistemi
Finnish Overflow System high water level
System Finland hochliegend
Système Finlandais avec niveau d'eau élevé

Fin Sistemi

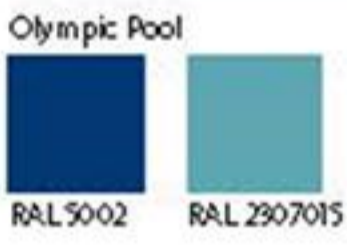

RAL 5002
RAL 2307015









RAL 5002
RAL 2307015



RAL 5002
RAL 2307015



Parlak Glossy Glänzend Brillant	Mat Matt	Fiyat grubu Price group Preisgruppe Groupe de prix		Ölçü Dimension Maße Dimensions	Adet / m Pieces / m Stüct / m Pièces / m	Adet / (utu) Pieces / Box Stüct / Palet Pièces / Boite	m ² / (utu) m ² / Box m ² / Palet m ² / Boite	kg / (utu) kg / Box kg / Palet kg / Boite
Havuz tutamağı Pool edge with finger grip Handfassenstein Rebord avec main courante				M 25x37,5 cm 244X369 mm				
K067733	K067722	EI-728	C 			4		14.00
K067735	K067744	EI-728	C 			4		14.00
Havuz tutamağı iç kögesi Pool edge with finger grip internal corner Handfassenstein Innerecke Angle intérieur de rebord avec main courante				M 37.5x37.5 cm 369X369 mm				
K067770	K067766	EI-750	C 			4		22.00
K067792	K067781	EI-750	C 			4		22.00
Havuz tutamağı dış kögesi Pool edge with finger grip external corner Handfassenstein Außerecke Angle extérieur de rebord avec main courante				M 37.5x37.5 cm 369X369 mm				
K067814	K067803	EI-750	C 			4		21.00
K067836	K067825	EI-750	C 			4		21.00

Arkitekt Pool Havuz Parçaları. Moulded Trims. Formstücke. Pièces moulées

Arkitekt
Pool

Fin Sistemi ızgara ayaklı
Finnish Overflow System high water level - with channel edge
System Finland hochliegend - mit integriertem Rostaufleger
Système Finlandais avec niveau d'eau élevé - avec goulotte

Fin Sistemi
ızgara ayaklı

Olympic Pool



RAL 5002



RAL 2307015

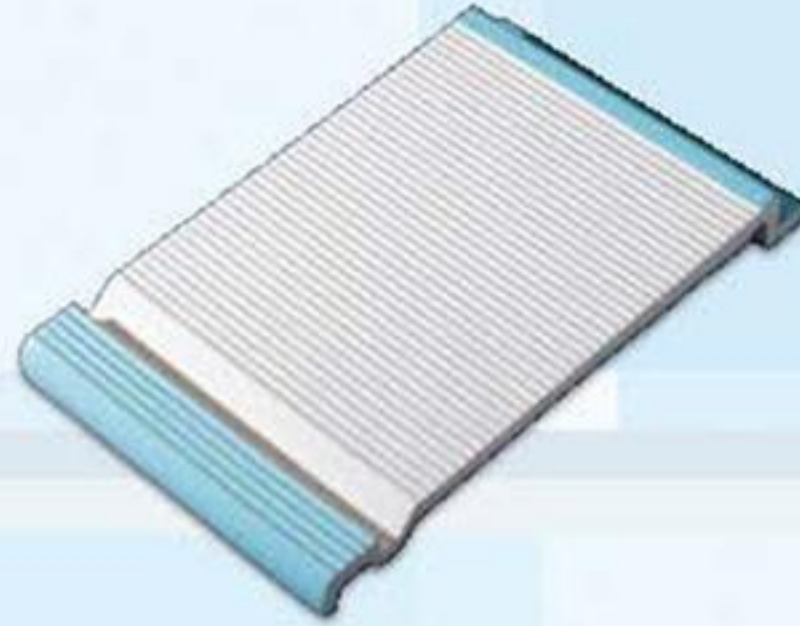

RAL 5002
RAL 2307015

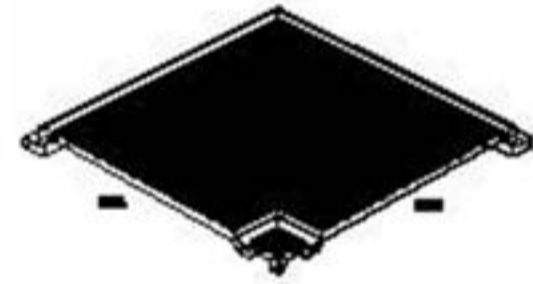
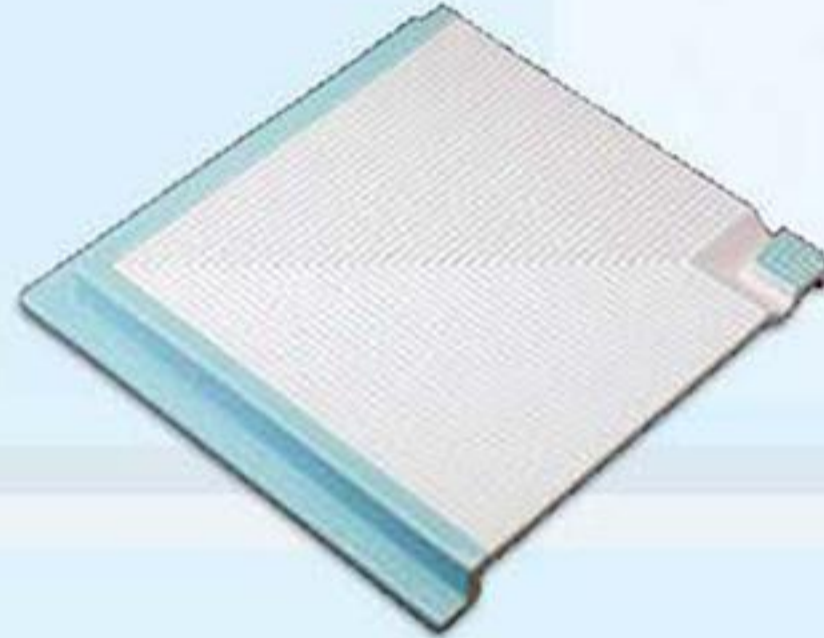



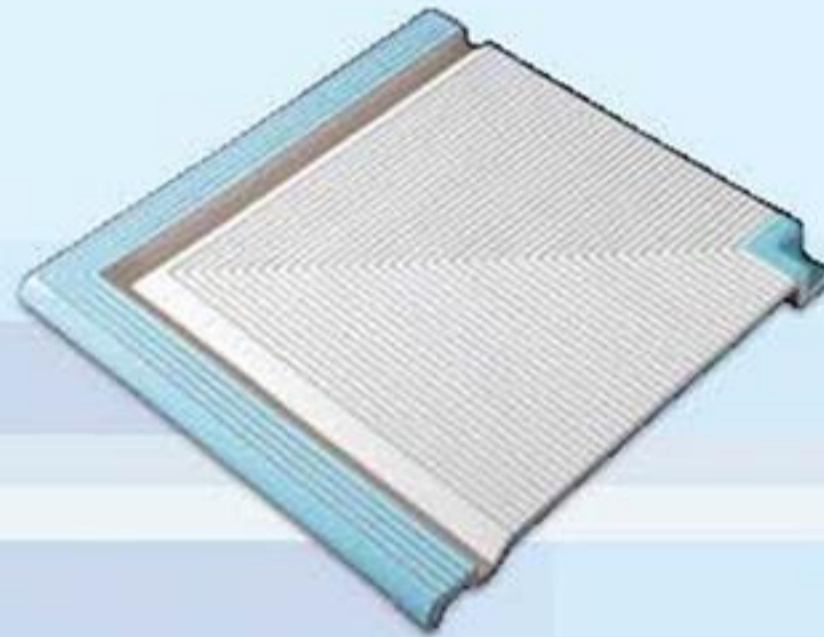



RAL 5002
RAL 2307015



RAL 5002
RAL 2307015



Parlak Glossy Glänzend Brillant	Mat Matt	Fiyat grubu Price group Preisgruppe Groupe de prix		Ölçü Dimension Maße Dimensions	Adet/m Pieces/m Stüct/m Pièces/m	Adet/İutu Pieces/Box Stüct/Palet Pièces/Boite	m ² /İutu m ² /Box m ² /Palet m ² /Boite	İg/İutu İg/Box İg/Palet İg/Boite
Izgara ayaldı tutamak Channel edge with fingerrip Handfasserstein mit integriertem Rostaufleger Rebord de bassin								
				M 37,5x25 cm 393x244 mm	4	4		14,80
					4	4		14,80
Izgara ayaldı tutamak iç kögesi Channel edge with fingerrip internal corner Handfasserstein Innenecke mit integriertem Rostaufleger Angle intérieur du rebord de bassin								
				M 37,5x37,5 cm 393x393 mm		4		23,00
						4		23,00
Izgara ayaldı İanal parça dış kögesi Channel edge with fingerrip external corner Handfasserstein Außenecke mit integriertem Rostaufleger Angle extérieur du rebord de bassin								
				M 37,5x37,5 cm 393x393 mm		4		22,00
						4		22,00

Arkitekt Pool

Arkitekt Pool Havuz Parçaları. Moulded Trims. Formstücke. Pièces moulées

Fin Sistemi
Finnish Overflow System high water level
System Finland hochliegend
Système Finlandais avec niveau d'eau élevé

Fin Sistemi

Olympic Pool



RAL 5002



RAL 2307015

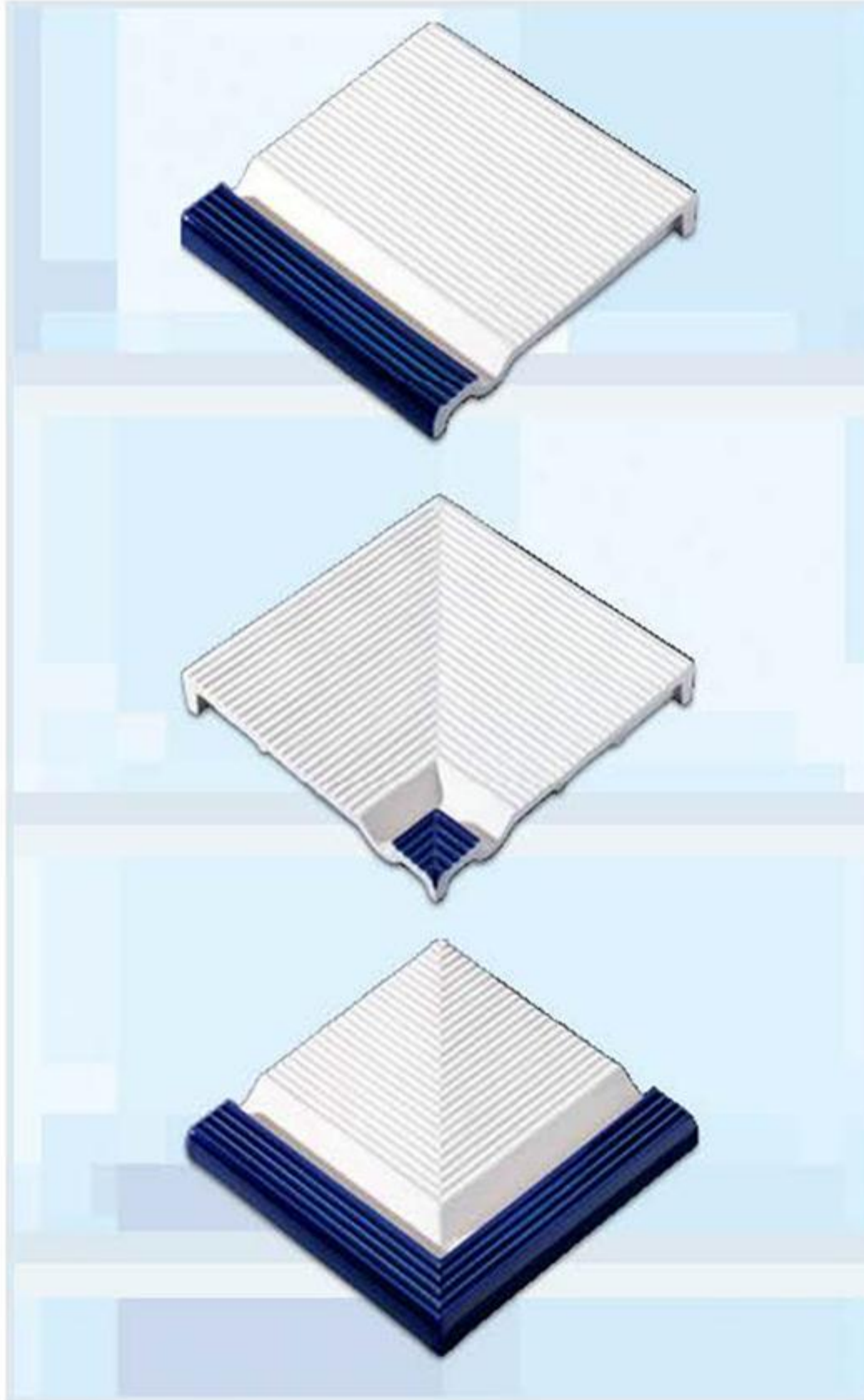

RAL 5002
RAL 2307015





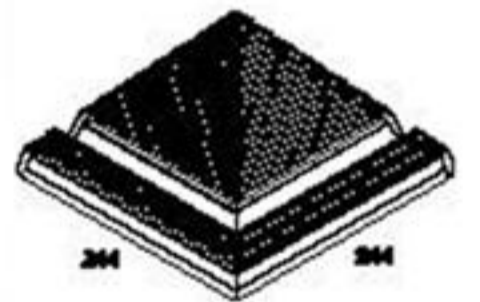



RAL 5002
RAL 2307015



RAL 5002
RAL 2307015



Parlak Glossy Glänzend Brillant	Mat Matt	Fiyat grubu Price group Preisgruppe Groupe de prix		Ölçü Dimension Maße Dimensions	Adet/m Pièces/m Stüçk/m Pièces/m	Adet/ütu Pièces/Box Stüçk/Palet Pièces/Boite	m²/ütu m²/Box m²/Palet m²/Boite	kg/ütu kg/Box kg/Palet kg/Boite
Havuz tutamağı Pool edge with finger grip Handfasserstein Rebord avec main courante								
10867615	10867604	E1-652	C 	M 25x25 cm 244X244 mm		4		9.00
10867630	10867626	E1-652	C 			4		9.00
Havuz tutamağı iç kögesi Pool edge with finger grip internal corner Handfasserstein Innenecke Angle intérieur de rebord avec main courante								
10867652	10867641	E1-674	C 	M 25x25 cm 244X244 mm		4		10.00
10867674	10867663	E1-674	C 			4		10.00
Havuz tutamağı dış kögesi Pool edge with finger grip external corner Handfasserstein Außenecke Angle extérieur de rebord avec main courante								
10867696	10867685	E1-674	C 	M 25x25 cm 244X244 mm		4		11.00
10867711	10867700	E1-674	C 			4		11.00

Arkitekt Pool

Arkitekt Pool Havuz Parçaları. Moulded Trims. Formstücke. Pièces moulées

Fin Sistemi ızgara ayaklı
Finnish Overflow System high water level - with channel edge
System Finnland hochliegend - mit integriertem Rostaufleger
Système Finlandais avec niveau d'eau élevé - avec goulotte

Fin Sistemi ızgara ayaklı

Olympic Pool



RAL 5002



RAL 2307015

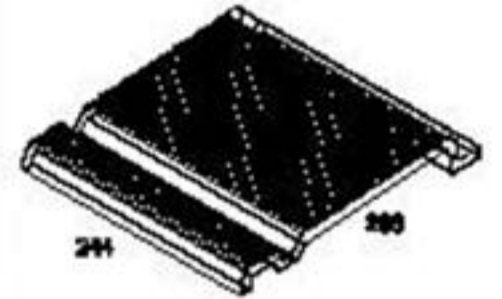
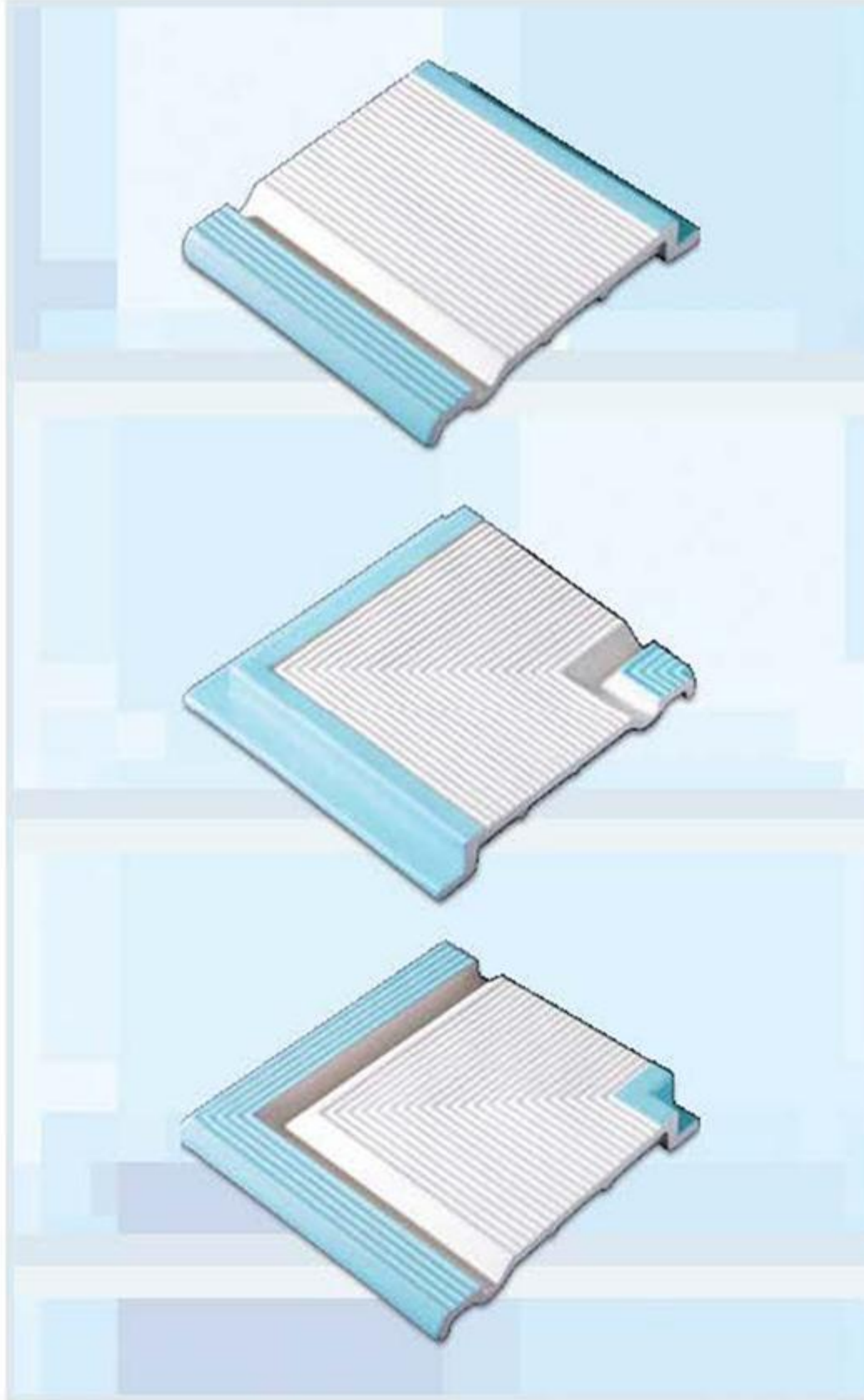

RAL 5002
RAL 2307015





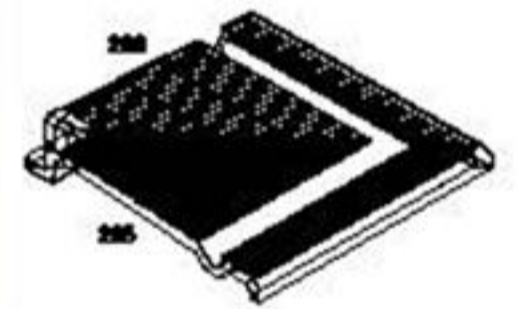



RAL 5002
RAL 2307015



RAL 5002
RAL 2307015



Parlak Glossy Glänzend Brillant	Mat Matt	Fiyat grubu Price group Preisgruppe Groupe de prix		Ölçü Dimension Maße Dimensions	Adet/m Pieces/m Stück/m Pièces/m	Adet/İkutu Pieces/Box Stück/Palet Pièces/Boîte	m ² /İkutu m ² /Box m ² /Palet m ² /Boîte	İlg./İkutu kg/Box İlg./Palet kg/Boîte
Izgara ayaldı tutamak Channel edge with finger grip Handfasserstein mit integriertem Rostaufleger Rebord de bassin								
				M 25x25 cm 244X268 mm				
10863880	10863876	E1-662	C 		4	4		10.00
10863902	10863891	E1-662	C 		4	4		10.00
Izgara ayaldı tutamak iç köşesi Channel edge with finger grip internal corner Handfasserstein Innenecke mit integriertem Rostaufleger Angle intérieur du rebord de bassin								
				M 25x25 cm 268X268 mm				
10863924	10863913	E1-674	C 			4		11.00
10863946	10863935	E1-674	C 			4		11.00
Izgara ayaldı İlanal parçası dış köşesi Channel edge with finger grip external corner Handfasserstein Außenecke mit integriertem Rostaufleger Angle extérieur du rebord de bassin								
				M 25x25 cm 268X268 mm				
10863961	10863950	E1-674	C 			4		12.00
10863983	10863972	E1-674	C 			4		12.00

Arkitekt Pool Havuz Parçaları. Moulded Trims. Formstücke. Pièces moulées

Arkitekt
Pool

Fin Sistemi ızgara ayaklı
Finnish Overflow System high water level - with channel edge
System Finland hochliegend - mit integriertem Rostaufleger
Système Finlandais avec niveau d'eau élevé - avec goulotte

Fin Sistemi
ızgara ayaklı

Olympic Pool



RAL 5002

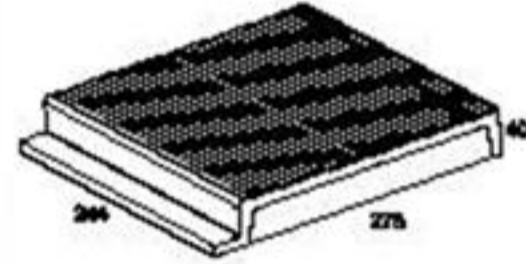
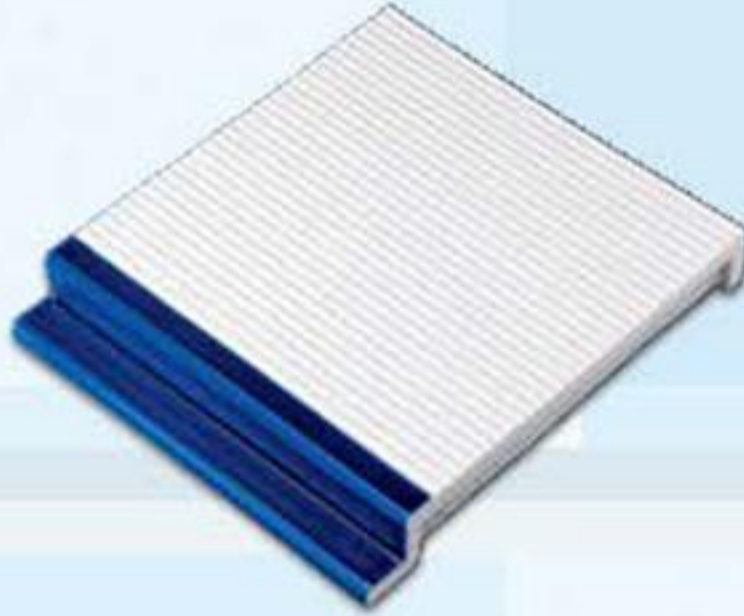

RAL 5002

Sırsız Unglazed Unglasiert Non émaillé

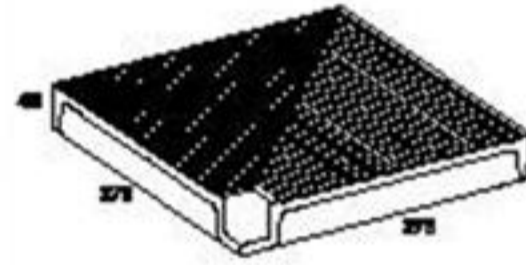
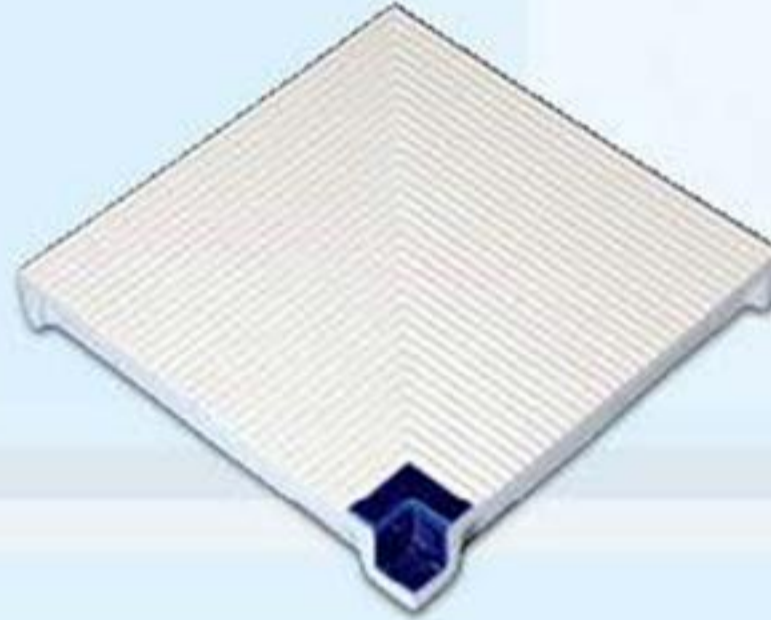

RAL 5002



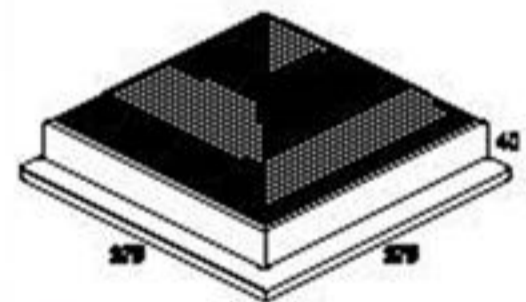
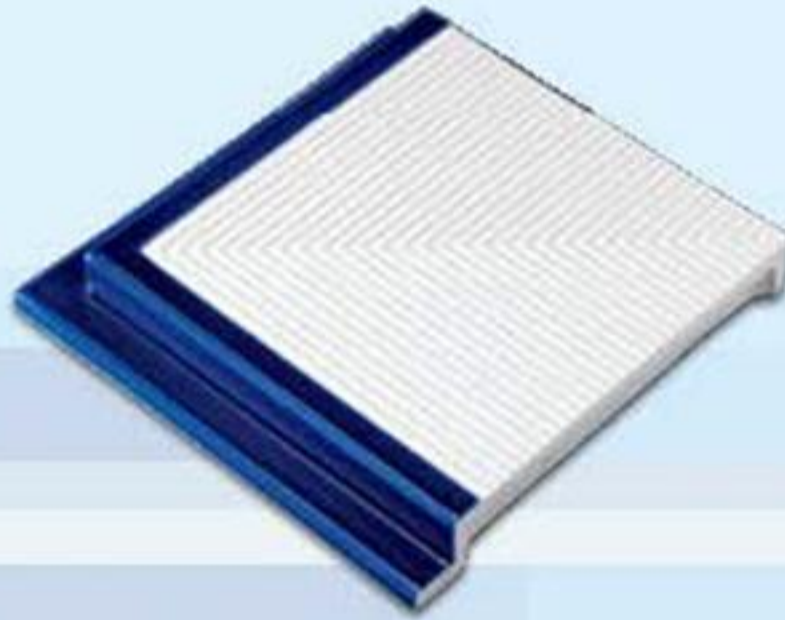



Sırsız Unglazed Unglasiert Non émaillé



RAL 5002

Sırsız Unglazed Unglasiert Non émaillé



Parlak Glossy Glänzend Brillant	Mat Matt	Fiyat grubu Price group Preisgruppe Groupe de prix		Ölçü Dimension Maße Dimensions	Adet/m Pieces/m Stüct/m Pièces/m	Adet/İutu Pieces/Box Stüct/Palet Pièces/Boite	m ² /İutu m ² /Box m ² /Palet m ² /Boite	İg/İutu İg/Box İg/Palet İg/Boite
Izgara ayaldı İrani parçası Channel edge Randstein mit integriertem Rostaufleger Goulotte de bassin								
M 25x25 cm 244X275 mm								
İ880370	İ880366	Eİ-653	C 		4	4		13.00
	İ880355	Eİ-650	C 		4	4		13.00
Izgara ayaldı İrani parçası iç İögesi Channel edge internal corner Randstein Innenecke mit integriertem Rostaufleger Angle intérieur de goulotte de bassin								
M 25x25 cm 275X275 mm								
İ881405	İ881394	Eİ-652	C 			4		14.60
	İ881383	Eİ-653	C 			4		14.60
Izgara ayaldı İrani parçası dış İögesi Channel edge external corner Randstein Außenecke mit integriertem Rostaufleger Angle extérieur de goulotte de bassin								
M 25x25 cm 275X275 mm								
İ881431	İ881420	Eİ-652	C 			4		14.00
	İ881416	Eİ-653	C 			4		14.00





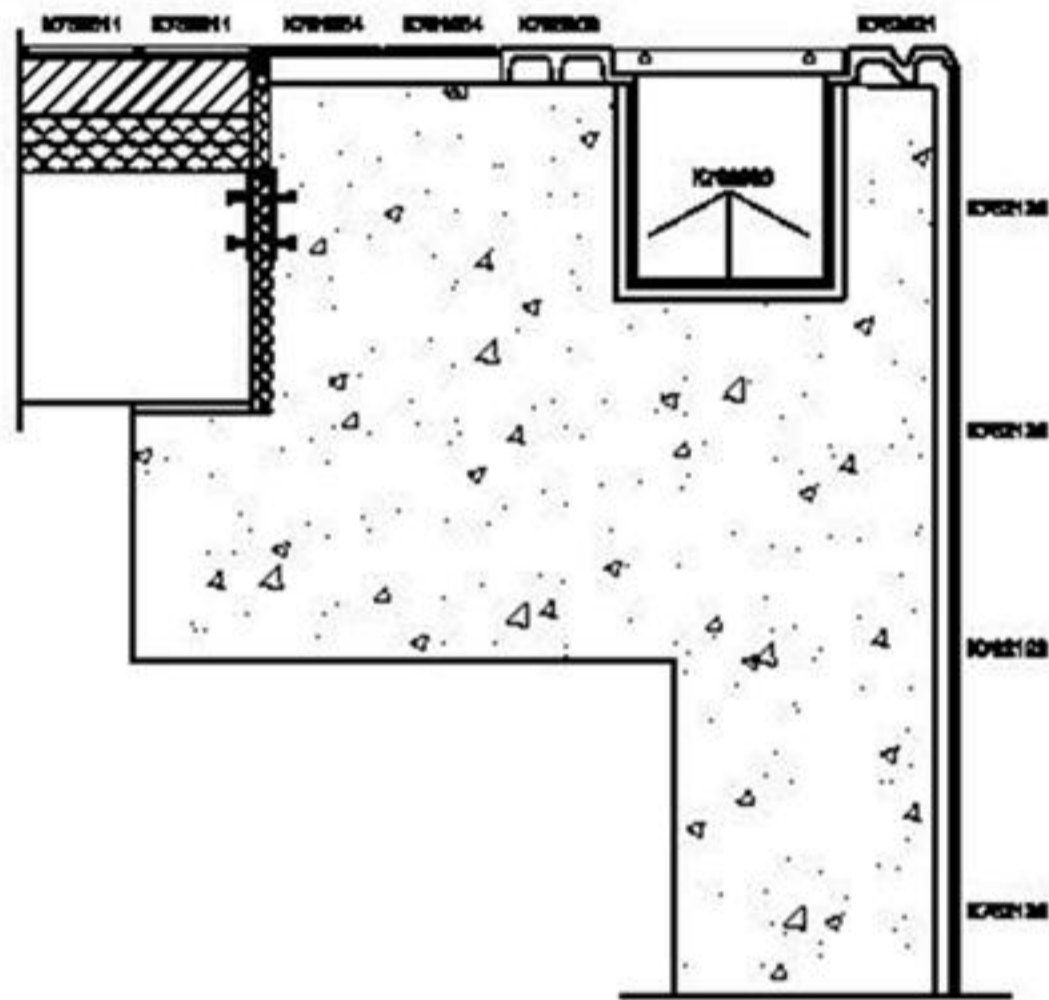

Arkitekt
Pool

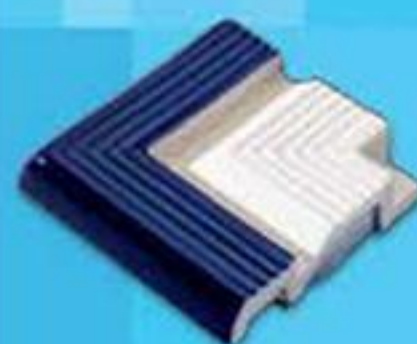

Fin Sistemi
Finnish Overflow System
System Finland
Système Finlandais

Izgara Ayaklı
High Water Level - With Channel Edge
Hochliegend - Mit Integriertem Rostaufleger
Avec Niveau D'eau Élevé - Avec Goulotte



Arkitekt Pool

Arkitekt Pool Havuz Parçaları. Moulded Trims. Formstücke. Pièces moulées

Fin Sistemi ızgara ayaklı

Finnish Overflow System high water level - with channel edge

System Finland hochliegend - mit integriertem Rostaufleger

Système Finlandais avec niveau d'eau élevé - avec goulotte

Fin Sistemi
ızgara ayaklı

Olympic Pool



RAL 5002

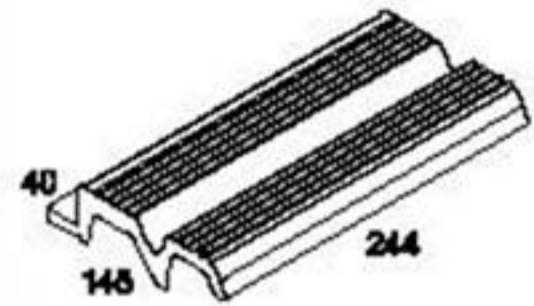

RAL 5002

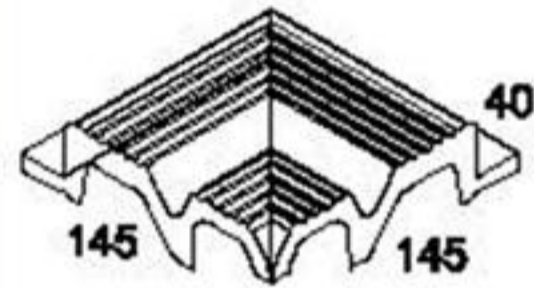

RAL 5002

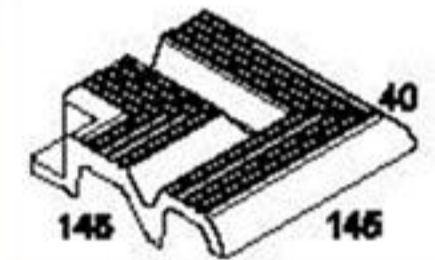
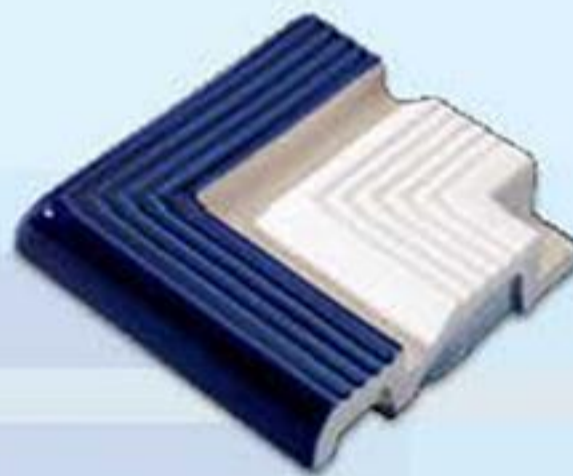

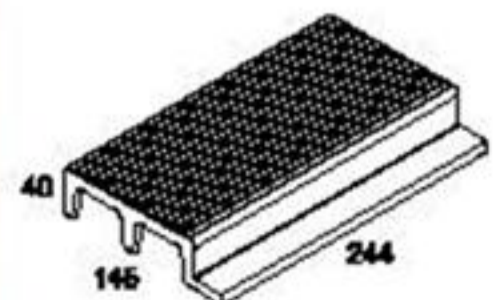
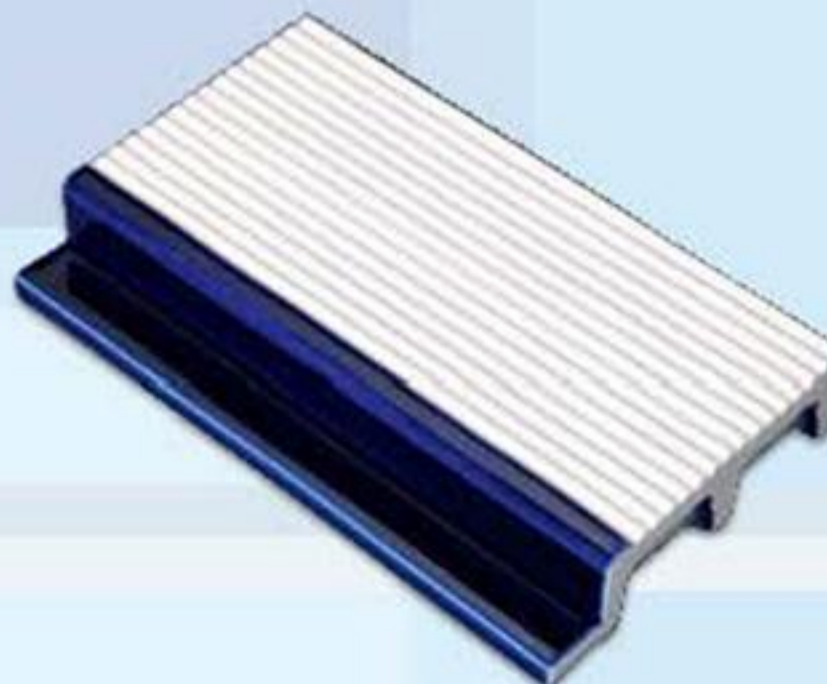

RAL 5002



RAL 5002

Sırsız Unglazed Unglasiert Non émailé



Parlak Glossy Glänzend Brillant	Mat Matt	Fiyat grubu Price group Preisgruppe Groupe de prix		Ölçü Dimension Maße Dimensions	Adet/m Pieces/m Stüct/m Pièces/m	Adet/İutu Pieces/Box Stüct/Palet Pièces/Boite	m ² /İutu m ² /Box m ² /Palet m ² /Boite	İg/İutu İg/Box İg/Palet İg/Boite
Izgara ayaldı tutamak Channel edge with finger grip Handfasserstein mit integriertem Rostaufleger Rebord de bassin				M 12,5x2,5cm 14,5x244x40 mm				
10792532	10792521	EI-385	C 		4	6		9,00
Izgara ayaldı tutamak iç kögesi Channel edge with finger grip internal corner Handfasserstein Innenecke mit integriertem Rostaufleger Angle intérieur du rebord de bassin				M 12,5x12,5cm 14,5x145x40 mm				
10792565	10792554	EI-389	C 			4		3,50
Izgara ayaldı tutamak dış kögesi Channel edge with finger grip external corner Handfasserstein Außenecke mit integriertem Rostaufleger Angle extérieur du rebord de bassin				M 12,5x12,5cm 14,5x145x40 mm				
10792591	10792580	EI-389	C 			4		3,50
Izgara ayaldı kanal parçası Channel edge Randstein mit integriertem Rostaufleger Goulotte de bassin				M 12,5x2,5cm 14,5x244x40 mm				
10785520	10786006 10789463	EI-382 EI-579	C  C 		4	6		9,40

Arkitekt Pool

Arkitekt Pool Havuz Parçaları. Moulded Trims. Formstücke. Pièces moulées

Fin Sistemi ızgara ayaklı
Finnish Overflow System high water level - with channel edge
System Finland hochliegend - mit integriertem Rostaufleger
Système Finlandais avec niveau d'eau élevé - avec goulotte

Fin Sistemi
ızgara ayaklı

Olympic Pool



RAL 5002

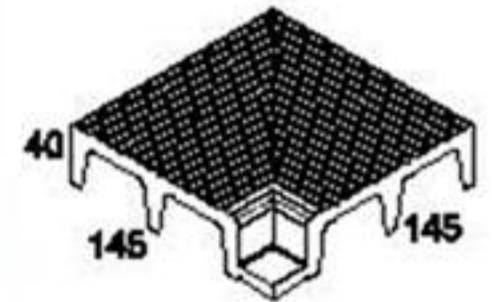
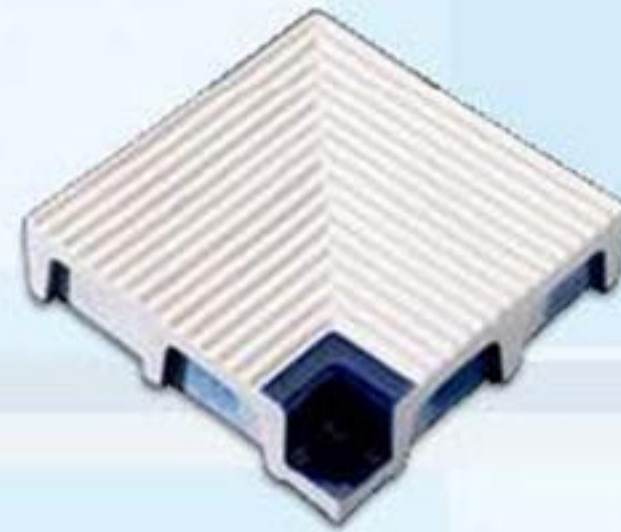

RAL 5002

Sırsız Unglazed Unglasiert Non émaillé

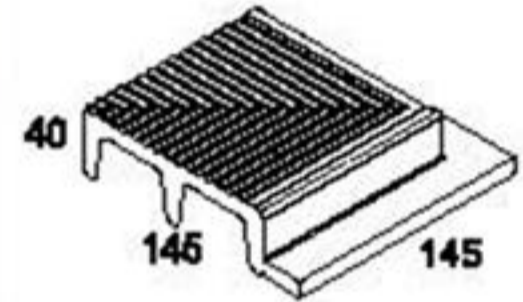
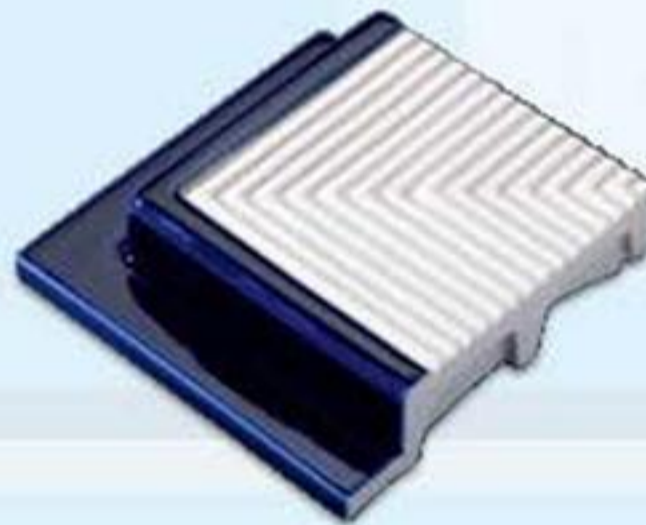

RAL 5002

Sırsız Unglazed Unglasiert Non émaillé

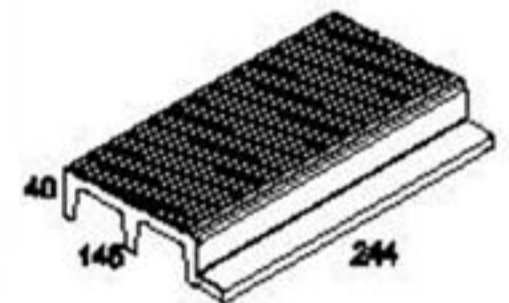
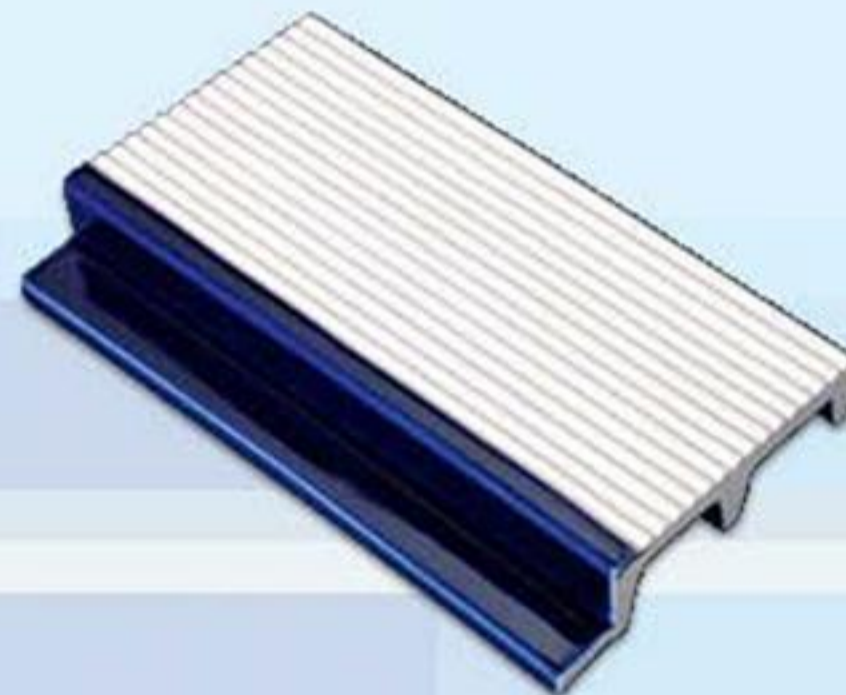

RAL 5002

Sırsız Unglazed Unglasiert Non émaillé

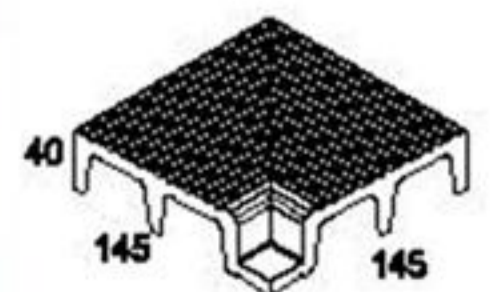
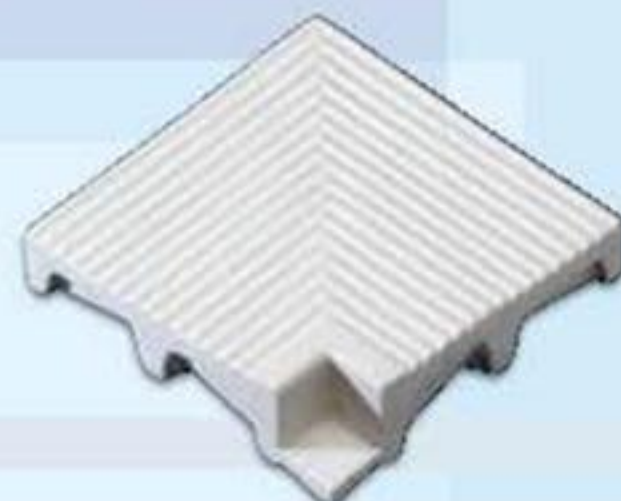

Sırsız Unglazed Unglasiert Non émaillé